



PROFESSIONAL DIGITAL TWO-WAY RADIO

MOTOTRBO™

SL2600

LIMITED KEYPAD PORTABLE RADIO

USER GUIDE

en-US

FEBRUARY 2021













© 2021 Motorola Solutions, Inc. All rights reserved.















MN003117A01-AG













Contents







Important Safety Information.....	10	2.7 Locking the Radio Display.....	23
Software Version.....	11	2.8 Unlocking the Radio Display.....	23
Copyrights.....	12	2.9 Adjusting the Volume.....	24
Computer Software Copyrights.....	14	Chapter 3: Radio Controls.....	25
Radio Care.....	15	3.1 Programmable Buttons.....	26
Chapter 1: Introduction.....	16	3.1.1 Assignable Radio Functions.....	26
1.1 Icon Information.....	16	3.1.2 Assignable Settings or Utility Functions.....	28
1.2 Conventional Analog and Digital Modes.....	16	3.1.3 Accessing Programmed Functions.....	28
1.3 IP Site Connect.....	17	3.2 Push-To-Talk Button.....	29
1.4 Capacity Plus.....	18	Chapter 4: Status Indicators.....	30
1.4.1 Capacity Plus–Single-Site.....	18	4.1 Icons.....	30
1.4.2 Capacity Plus–Multi-Site	18	4.2 LED Indicators	34
Chapter 2: Getting Started.....	20	4.3 Tones.....	35
2.1 Charging the Battery.....	20	4.3.1 Audio Tones.....	36
2.2 Attaching the Battery.....	20	4.3.2 Indicator Tones.....	36
2.3 Attaching the Antenna.....	21	Chapter 5: Zone and Channel Selections.....	37
2.4 Attaching the Earpiece/Audio Accessory.....	22	5.1 Selecting Zones	37
2.5 Turning the Radio On.....	22	5.2 Selecting Channels.....	37
2.6 Turning the Radio Off.....	23	Chapter 6: Calls.....	38
		6.1 Group Calls.....	38



6.1.1 Making Group Calls.....	39	6.6 Initiating Transmit Interrupt 	50
6.1.2 Responding to Group Calls.....	39	6.7 Broadcast Voice Calls.....	50
6.2 Private Calls 	40	6.7.1 Making Broadcast Voice Calls.....	50
6.2.1 Making Private Calls 	40	6.7.2 Receiving Broadcast Voice Calls...	50
6.2.2 Responding to Private Calls 	41	6.8 Unaddressed Calls.....	51
6.3 All Calls.....	42	6.8.1 Making Unaddressed Calls.....	51
6.3.1 Making All Calls.....	42	6.8.2 Responding to Unaddressed Calls.....	52
6.3.2 Receiving All Calls.....	42	6.9 Open Voice Channel Mode (OVCM).....	52
6.4 Selective Calls 	43	6.9.1 Making OVCM Calls.....	53
6.4.1 Making Selective Calls.....	43	6.9.2 Responding to OVCM Calls.....	53
6.4.2 Responding to Selective Calls 	44	Chapter 7: Advanced Features.....	55
6.5 Phone Calls 	44	7.1 Bluetooth®.....	55
6.5.1 Making Phone Calls 	45	7.1.1 Turning Bluetooth On and Off.....	55
6.5.2 Making Phone Calls with the Programmable Phone Button 	46	7.1.2 Connecting to Bluetooth Devices...	56
6.5.3 Responding to Phone Calls as Group Calls 	48	7.1.3 Connecting to Bluetooth Devices in Discoverable Mode.....	57
6.5.4 Responding to Phone Calls as Private Calls 	48	7.1.4 Disconnecting from Bluetooth Devices.....	58
6.5.5 Responding to Phone Calls as All Calls 	49	7.1.5 Switching Audio Route between Internal Radio Speaker and Bluetooth Device.....	58

7.1.6 Viewing Device Details.....	59	7.6.1 Initiating Remote Monitor.....	66
7.1.7 Deleting Device Name.....	59	7.6.2 Initiating Remote Monitor by Using the Contacts List	67
7.1.8 Bluetooth Mic Gain.....	59	7.6.3 Initiating Remote Monitor by Using the Manual Dial	68
7.1.9 Permanent Bluetooth Discoverable Mode.....	60	7.7 Radio Check 	69
7.2 Indoor Location.....	60	7.7.1 Sending Radio Checks 	69
7.2.1 Turning Indoor Location On or Off	61	7.7.2 Sending Radio Checks by Using the Contacts List 	70
7.2.2 Accessing Indoor Location Beacons Information.....	62	7.8 Scan Lists.....	70
7.3 Talkaround.....	62	7.8.1 Viewing Entries in the Scan List ...	71
7.3.1 Toggling Between Repeater and Talkaround Modes.....	63	7.8.2 Adding New Entries to the Scan List.....	71
7.4 Monitor Feature	63	7.8.3 Deleting Entries from the Scan List.....	72
7.4.1 Monitoring Channels.....	63	7.8.4 Setting Priority for Entries in the Scan List.....	73
7.4.2 Permanent Monitor	64	7.9 Scan.....	73
7.4.2.1 Turning Permanent Monitor On or Off.....	64	7.9.1 Turning Scan On or Off	74
7.5 Home Channel Reminder.....	64	7.9.2 Responding to Transmissions During Scanning.....	74
7.5.1 Muting the Home Channel Reminder.....	65	7.9.3 Deleting Nuisance Channels.....	75
7.5.2 Setting New Home Channels.....	65		
7.6 Remote Monitor.....	65		

7.9.4 Restoring Nuisance Channels.....	75	7.13.1 Viewing Recent Calls.....	84
 7.10 Vote Scan	75	7.13.2 Deleting Calls from the Call List 	84
7.11 Contacts Settings.....	76	7.13.3 Viewing Call List Details 	85
7.11.1 Making Group Calls by Using the Contacts List	77	7.14 Call Alert Operation.....	86
7.11.2 Making Private Calls by Using the Contacts List 	77	7.14.1 Responding to Call Alerts	86
7.11.3 Setting Default Contact 	78	7.14.2 Making Call Alerts.....	86
7.12 Call Indicator Settings.....	79	7.14.3 Making Call Alerts by Using the Contacts List.....	87
7.12.1 Activating or Deactivating Call Ringers for Call Alerts.....	79	7.15 Mute Mode.....	87
7.12.2 Activating or Deactivating Call Ringers for Private Calls 	80	7.15.1 Turning On Mute Mode.....	88
7.12.3 Activating or Deactivating Call Ringers for Selective Calls 	80	7.15.2 Setting Mute Mode Timer.....	88
7.12.4 Activating or Deactivating Call Ringers for Text Messages 	81	7.15.3 Exiting Mute Mode.....	89
7.12.5 Assigning Ring Styles.....	82	7.16 Emergency Operation	89
7.12.6 Selecting a Ring Alert Type.....	83	7.16.1 Sending Emergency Alarms	90
7.12.7 Alarm Tone Volume Escalation... ..	84	7.16.2 Sending Emergency Alarms with Call	91
7.13 Call Log Features	84	7.16.3 Emergency Alarms with Voice to Follow	93
		7.16.4 Sending Emergency Alarms with Voice to Follow 	93
		7.16.5 Receiving Emergency Alarms.....	94

7.16.6 Reinitiating Emergency Mode.....	95	7.18.1 Sending Status Updates to Predefined Contacts 	103
7.16.7 Exiting Emergency Mode After Sending the Emergency Alarm.....	95	7.18.2 Viewing 5-Tone Status Details...	104
7.17 Text Messaging	96	7.19 Analog Message Encode.....	105
7.17.1 Sending Quick Text Messages 	96	7.19.1 Sending MDC Encode Messages to Dispatchers 	105
7.17.2 Resending Text Messages.....	97	7.19.2 Sending 5-Tone Encode Messages to Contacts 	106
7.17.3 Forwarding Text Messages 	98	7.20 Setting a Default 5-Tone Contact.....	106
7.17.4 Viewing Sent Text Messages 	99	7.20.1 Making 5-Tone Calls.....	107
7.17.5 Sending Sent Text Messages 	99	7.20.2 Receiving 5-Tone Calls.....	108
7.17.6 Deleting All Sent Text Messages from the Sent Items Folder .	100	7.20.3 Sending 5-Tone Emergency Alarm.....	108
7.17.7 Responding to Text Messages 	101	7.20.4 Sending 5-Tone Emergency Alarm with Voice to Follow.....	108
7.17.8 Viewing Text Messages.....	101	7.20.5 Receiving 5-Tone Emergency Alarm.....	109
7.17.9 Deleting Text Messages from the Inbox.....	102	7.21 Privacy 	110
7.17.10 Deleting All Text Messages from the Inbox 	103	7.21.1 Turning Privacy On or Off 	111
7.18 Analog Status Update 	103	7.22 Response Inhibit.....	111
		7.22.1 Turning Response Inhibit On or Off.....	112

- 7.23 Covert Mode..... 112
 - 7.23.1 Entering Covert Mode..... 112
 - 7.23.2 Exiting Covert Mode..... 112
- 7.24 Security  112
 - 7.24.1 Disabling Radios  113
 - 7.24.2 Disabling Radios by Using the Contacts List  114
 - 7.24.3 Disabling Radios by Using the Manual Dial  115
 - 7.24.4 Enabling Radios  116
 - 7.24.5 Enabling Radios by Using the Contacts List  116
 - 7.24.6 Enabling Radios by Using the Manual Dial  117
- 7.25 Lone Worker..... 118
- 7.26 Password Lock..... 119
 - 7.26.1 Accessing the Radio by Using Password..... 119
 - 7.26.2 Unlocking Radios in Locked State..... 120
 - 7.26.3 Turning Password Lock On or Off..... 120

- 7.26.4 Changing Passwords..... 121
- 7.27 Notification List 122
 - 7.27.1 Accessing Notification List 123
- 7.28 Auto-Range Transponder System  123
- 7.29 Over-the-Air Programming  124
- 7.30 Wi-Fi Operation..... 124
 - 7.30.1 Turning Wi-Fi On or Off..... 125
 - 7.30.2 Turning Wi-Fi On or Off Remotely by Using a Designated Radio (Individual Control)..... 126
 - 7.30.3 Turning Wi-Fi On or Off Remotely by Using a Designated Radio (Group Control)..... 127
 - 7.30.4 Connecting to a Network Access Point..... 127
 - 7.30.5 Checking Wi-Fi Connection Status..... 128
 - 7.30.6 Viewing Details of Network Access Points..... 129
- Chapter 8: Utilities..... 130
 - 8.1 Squelch Levels 130

8.1.1 Setting Squelch Levels	130	8.17 Turning Digital Microphone AGC On or Off	141
8.2 Power Levels.....	131	8.18 Turning Intelligent Audio On or Off.....	142
8.2.1 Setting Power Levels.....	131	8.19 Turning Trill Enhancement On or Off.....	143
8.3 Adjusting Display Brightness.....	132	8.20 Turning Acoustic Feedback Suppressor On or Off 	143
8.4 Voice Operating Transmission.....	132	8.21 General Radio Information	144
8.4.1 Turning Voice Operating Transmission On or Off.....	133	8.21.1 Accessing Battery Information ..	144
8.5 Setting Display Backlight Timer.....	134	8.21.2 Checking Radio Alias and ID	145
8.6 Turning Radio Tones/Alerts On or Off.....	134	8.21.3 Checking Firmware and Codeplug Versions.....	145
8.7 Turning Power Up Tone On or Off.....	135	8.21.4 Checking Software Update Information.....	146
8.8 Setting Tones/Alerts Volume Offset Levels	136	8.22 Received Signal Strength Indicator.....	146
8.9 Turning Talk Permit Tone On or Off.....	136	8.22.1 Viewing RSSI Values.....	146
8.10 Setting Languages.....	137	8.23 Viewing Enterprise Wi-Fi Certificate Details.....	146
8.11 Turning LED Indicators On or Off.....	137	Chapter 9: Authorized Accessories List.....	148
8.12 Turning Introduction Screen On or Off....	138	Limited Warranty.....	151
8.13 Turning Voice Announcement On or Off	139	MOTOROLA SOLUTIONS COMMUNICATION PRODUCTS.....	151
8.14 Turning Automatic Call Forwarding On or Off.....	140	I. WHAT THIS WARRANTY COVERS AND FOR HOW LONG:.....	151
8.15 Setting Menu Timer.....	140		
8.16 Turning Analog Microphone AGC On or Off	141		

- II. GENERAL PROVISIONS..... 152
- III. STATE LAW RIGHTS:..... 152
- IV. HOW TO GET WARRANTY SERVICE..... 152
- V. WHAT THIS WARRANTY DOES NOT
COVER..... 152
- VI. PATENT AND SOFTWARE PROVISIONS 153
- VII. GOVERNING LAW..... 154
- VIII. For Australia Only..... 154

Important Safety Information



CAUTION:

This radio is restricted to Occupational use only.

Before using the radio, read the RF Energy Exposure and Product Safety Guide for Portable Two-Way Radios which contains important operating instructions for safe usage and RF energy awareness and control for Compliance with applicable standards and Regulations.

Software Version

All the features described in the following sections are supported by the software version **R02.21.01.0000** or later.

See [Checking Firmware and Codeplug Versions on page 145](#) to determine the software version of your radio.

Contact your dealer or administrator for more information.

Copyrights

The Motorola Solutions products described in this document may include copyrighted Motorola Solutions computer programs. Laws in the United States and other countries preserve for Motorola Solutions certain exclusive rights for copyrighted computer programs. Accordingly, any copyrighted Motorola Solutions computer programs contained in the Motorola Solutions products described in this document may not be copied or reproduced in any manner without the express written permission of Motorola Solutions.

© 2021 Motorola Solutions, Inc. All Rights Reserved

No part of this document may be reproduced, transmitted, stored in a retrieval system, or translated into any language or computer language, in any form or by any means, without the prior written permission of Motorola Solutions, Inc.

Furthermore, the purchase of Motorola Solutions products shall not be deemed to grant either directly or by implication, estoppel or otherwise, any license under the copyrights, patents or patent applications of Motorola Solutions, except for the normal non-exclusive, royalty-free license to use that arises by operation of law in the sale of a product.

Disclaimer

Please note that certain features, facilities, and capabilities described in this document may not be applicable to or licensed for use on a specific system, or may be dependent upon the characteristics of a specific mobile subscriber unit or configuration of certain parameters. Please refer to your Motorola Solutions contact for further information.

Trademarks

MOTOROLA, MOTO, MOTOROLA SOLUTIONS, and the Stylized M Logo are trademarks or registered trademarks of Motorola Trademark Holdings, LLC and are used under license. All other trademarks are the property of their respective owners.

Open Source Content

This product contains Open Source software used under license. Refer to the product installation media for full Open Source Legal Notices and Attribution content.

European Union (EU) Waste of Electrical and Electronic Equipment (WEEE) directive



■ The European Union's WEEE directive requires that products sold into EU countries must have the crossed out trash bin label on the product (or the package in some cases).

As defined by the WEEE directive, this cross-out trash bin label means that customers and end-users in EU countries should not dispose of electronic and electrical equipment or accessories in household waste.

Customers or end-users in EU countries should contact their local equipment supplier representative or service centre for information about the waste collection system in their country.

Computer Software Copyrights

The Motorola Solutions products described in this manual may include copyrighted Motorola Solutions computer programs stored in semiconductor memories or other media. Laws in the United States and other countries preserve for Motorola Solutions certain exclusive rights for copyrighted computer programs including, but not limited to, the exclusive right to copy or reproduce in any form the copyrighted computer program. Accordingly, any copyrighted Motorola Solutions computer programs contained in the Motorola Solutions products described in this manual may not be copied, reproduced, modified, reverse-engineered, or distributed in any manner without the express written permission of Motorola Solutions. Furthermore, the purchase of Motorola Solutions products shall not be deemed to grant either directly or by implication, estoppel, or otherwise, any license under the copyrights, patents or patent applications of Motorola Solutions, except for the normal non-exclusive license to use that arises by operation of law in the sale of a product.

The AMBE+2™ voice coding Technology embodied in this product is protected by intellectual property rights including

patent rights, copyrights and trade secrets of Digital Voice Systems, Inc.

This voice coding Technology is licensed solely for use within this Communications Equipment. The user of this Technology is explicitly prohibited from attempting to decompile, reverse engineer, or disassemble the Object Code, or in any other way convert the Object Code into a human-readable form.

U.S. Pat. Nos. #5,870,405, #5,826,222, #5,754,974, #5,701,390, #5,715,365, #5,649,050, #5,630,011, #5,581,656, #5,517,511, #5,491,772, #5,247,579, #5,226,084 and #5,195,166.

Radio Care

This section describes the basic handling precaution of the radio.

Table 1: IP Specification

IP Specification	Description
IP54	Allows your radio to withstand adverse field conditions such as being exposed to water or dust.



CAUTION:

Do not disassemble your radio. This could damage radio seals and result in leak paths into the radio. Radio maintenance should only be done in service depot that is equipped to test and replace the seal on the radio.

- Keep your radio clean and exposure to water should be avoided to help ensure proper functionality and performance.
- To clean the exterior surfaces of the radio, use a diluted solution of mild dishwashing detergent and fresh water (for example, one teaspoon of detergent to one gallon of water).
- These surfaces should be cleaned whenever a periodic visual inspection reveals the presence of smudges, grease, and/or grime.



CAUTION:

The effects of certain chemicals and their vapors can have harmful results on certain plastics. Avoid using aerosol sprays, tuner cleaners, and other chemicals.

Introduction

This user guide covers the operation of your radios.

Your dealer or system administrator may have customized your radio for your specific needs. Check with your dealer or system administrator for more information.

You can consult your dealer or system administrator about the following:

- Is your radio programmed with any preset conventional channels?
- Which buttons have been programmed to access other features?
- What optional accessories may suit your needs?
- What are the best radio usage practices for effective communication?
- What maintenance procedures that helps promote longer radio life?

1.1

Icon Information

Throughout this publication, the icons described are used to indicate features supported in either the conventional analog or conventional digital mode.



Indicates a conventional **Analog Mode-Only** feature.



Indicates a conventional **Digital Mode-Only** feature.

For features that are available in **both** conventional analog and digital modes, both icons are **not** shown.

1.2

Conventional Analog and Digital Modes

Each channel in your radio can be configured as a conventional analog or conventional digital channel.

1 : Channel Selector Knob

Certain features are unavailable when switching from digital to analog mode. The icons for digital features reflect this change by appearing “grayed out”. The disabled features are hidden in the menu.

Your radio also has features available in both analog and digital modes. The minor differences in the way each feature works do **not** affect the performance of your radio.

**NOTICE:**

Your radio also switches between digital and analog modes during a dual mode scan. See [Scan on page 73](#) for more information.

1.3

IP Site Connect

This feature allows your radio to extend conventional communication beyond the reach of a single site by connecting to different available sites by using an Internet Protocol (IP) network.

When the radio moves out of range from one site and into the range of another, the radio connects to the repeater of the new site to send or receive calls or data transmissions. This is done either automatically or manually depending on your settings.

In an automatic site search, the radio scans through all available sites when the signal from the current site is weak or when the radio is unable to detect any signal from the current site. The radio then locks on to the repeater with the strongest Received Signal Strength Indicator (RSSI) value.

In a manual site search, the radio searches for the next site in the roam list that is currently in range but which may not have the strongest signal and locks on to the repeater.

**NOTICE:**

Each channel can only have either Scan or Roam enabled, not both at the same time.

Channels with this feature enabled can be added to a particular roam list. The radio searches the channels in the roam list during the automatic roam operation to locate the best site. A roam list supports a maximum of 16 channels, including the selected channel.

**NOTICE:**

You cannot manually add or delete an entry in the roam list. Contact your dealer for more information.

1.4

Capacity Plus

Capacity Plus is an entry-level trunked system for single and multiple sites. The single and multi-site dynamic trunking offers better capacity and coverage.

1.4.1

Capacity Plus–Single-Site

Capacity Plus–Single-Site is a single-site trunking configuration of the MOTOTRBO radio system, which uses a pool of channels to support hundreds of users and up to 254 Groups. This feature allows your radio to efficiently utilize the available number of programmed channels while in Repeater Mode.

You hear a negative indicator tone if you try to access a feature not applicable to Capacity Plus–Single-Site by using a programmable button press.

Your radio also has features that are available in conventional digital mode, IP Site Connect, and Capacity Plus. However, the minor differences in the way each feature works does not affect the performance of your radio.

Check with your dealer or system administrator for more information on this configuration.

1.4.2

Capacity Plus–Multi-Site

Capacity Plus–Multi-Site is a multi-channel trunking configuration of the MOTOTRBO radio system, combining the best of both Capacity Plus and IP Site Connect configurations.

Capacity Plus–Multi-Site allows your radio to extend trunking communication beyond the reach of a single site, by connecting to different available sites which are connected with an IP network. It also provides an increase in capacity by efficiently utilizing the combined available number of programmed channels supported by each of the available sites.

When the radio moves out of range from one site and into the range of another, it connects to the repeater of the new site to send or receive calls/data transmissions. Depending on your settings, this is done automatically or manually.

If the radio is set to do this automatically, it scans through all available sites when the signal from the current site is weak or when the radio is unable to detect any signal from

the current site. It then locks on to the repeater with the strongest RSSI value.

In a manual site search, the radio searches for the next site in the roam list that is currently in range (but which may not have the strongest signal) and locks on to it.

Any channel with Capacity Plus–Multi-Site enabled can be added to a particular roam list. The radio searches these channels during the automatic roam operation to locate the best site.

**NOTICE:**

You cannot manually add or delete an entry to the roam list. Check with your dealer or system administrator for more information.

Similar to Capacity Plus–Single Site, icons of features not applicable to Capacity Plus–Multi-Site are not available in the menu. You hear a negative indicator tone if you try to access a feature not applicable to Capacity Plus–Multi-Site by using a programmable button press.

Getting Started

Getting Started provides instructions to prepare your radio for use.

2.1

Charging the Battery

Your radio is powered by a Lithium-Ion (Li-Ion) battery.

Turn off your radio when charging.

- To comply with warranty terms and avoid damages, charge the battery using a Motorola Solutions authorized charger as described in the charger user guide.
- Charge a new battery 14 to 16 hours before initial use for best performance.

Batteries charge best at room temperature.

**NOTICE:**

PC USB charging is not supported on flat battery.

You may charge your battery by connecting the USB charger to a nearby and easily accessible wall power outlet.

2.2

Attaching the Battery

Follow the procedure to attach the battery to your radio.

- 1 Align the battery contacts with the contacts inside the battery compartment. Insert the contact side of the battery first. Gently push the battery into place.

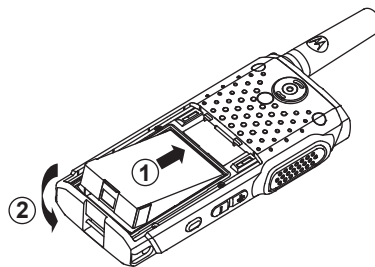

- 2 To attach battery cover, align it in place and slide the battery latch until it snaps into place.

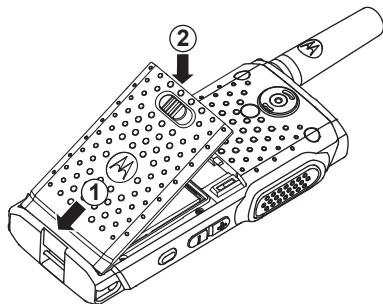

3 Slide battery latch into lock position.

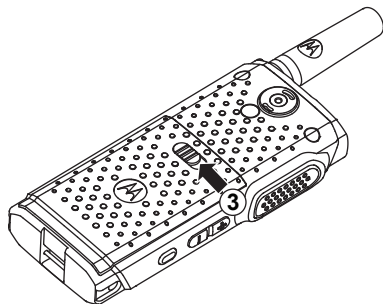

Attaching the Antenna

Turn off your radio.

Set the antenna in the receptacle and turn clockwise.



NOTICE:

To protect best against water and dust, ensure that antenna is tightly fitted.

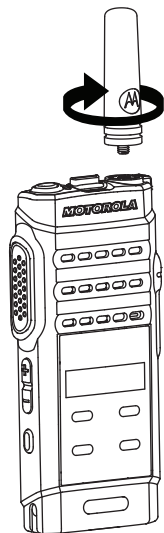
**NOTICE:**

To remove the antenna, turn the antenna counterclockwise.

**CAUTION:**

To prevent damages, replace the faulty antenna with only MOTOTRBO antennas.

**NOTICE:**

When attaching a VHF antenna to the radio, the CPS configuration for antenna selection must match the chosen VHF antenna. A mismatch in antennas results in decreased range.

2.4

Attaching the Earpiece/Audio Accessory

The audio accessory connector is located on the right side of the radio. Follow the procedure to attach accessories to your radio.

- 1 Lift the flap of the audio jack cover.
-
- 2 Align the indicators on both the connector and housing, then push until it fits in properly.
-

2.5

Turning the Radio On

- 1 Rotate the **On/Off/Volume Control** knob clockwise to turn on the radio.
-

- 2 Long press the **On/Off** button to power up the radio when charging or otherwise.
-

If successful, your radio shows the following indications:

- A tone sounds.



NOTICE:

If the Tones/Alerts function is disabled, there is no tone upon powering up.

- The green LED lights up.
- The display shows a power-on animation.

When the radio is idle, the LED displays a blinking green light to indicate that the radio is on. The blinking green light turns off in the presence of other LED activity and resumes when radio returns to idle mode.

If your radio does not power up, check your battery. Make sure that the battery is charged and properly attached. Contact your dealer if your radio still does not power up.

2.6

Turning the Radio Off

- 1 Rotate the **On/Off/Volume Control** knob anti clockwise to turn off the radio.
-

- 2 Long press the **On/Off** button.
-

2.7

Locking the Radio Display

You can lock your radio screen to avoid an inadvertent key entry. Follow the procedure to lock the radio display.

Short press the **On/Off** button.

- The radio display turns off.
 - The touch screen keypad is hidden and inactive.
-

2.8

Unlocking the Radio Display

Follow the procedure to unlock the radio display.

Short press the **On/Off** button.

- The radio display lights up.
 - The touch screen keypad becomes visible and active.
-

2.9

Adjusting the Volume

To adjust the volume of your radio, perform one of the following actions:

- To increase the volume, press the **Volume Up** button.
- To decrease the volume, press the **Volume Down** button.
- To increase the volume, turn the **On/Off/Volume Control** knob clockwise.
- To decrease the volume, turn the **On/Off/Volume Control** knob counterclockwise.



NOTICE:

Your radio can be programmed to have a minimum volume offset where the volume level cannot be lowered past the programmed minimum volume.

Radio Controls

This chapter explains the buttons and functions to control the radio.

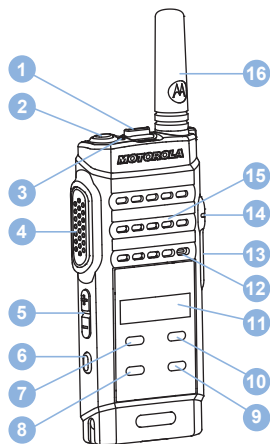

- 1 Channel Rocker
- 2 On/Off Button
- 3 LED Indicator

- 4 Push-to-Talk (PTT) Button
- 5 Volume Button
- 6 Side Button 1¹
- 7 P1/Left Navigation Button²
- 8 Menu/OK Button²
- 9 Back/Home Button²
- 10 P2/Right Navigation Button²
- 11 Display
- 12 Microphone
- 13 USB Connector
- 14 Accessory Connector
- 15 Speaker
- 16 Antenna

¹ This button is programmable.

² These touch screen buttons become visible when the radio is unlocked.

3.1

Programmable Buttons

Depending on the duration of a button press, your dealer can program the programmable buttons as shortcuts to radio functions.

Short press

Pressing and releasing rapidly.

Long press

Pressing and holding for the programmed duration.



NOTICE:

See [Emergency Operation on page 89](#) for more information on the programmed duration of the **Emergency** button.

3.1.1

Assignable Radio Functions

The following radio functions can be assigned to the programmable buttons.

Audio Toggle

Toggles audio routing between the internal radio speaker and the speaker of a wired accessory.

Contacts

Provides direct access to the Contacts list.

Call Alert

Provides direct access to the contacts list for you to select a contact to whom a Call Alert can be sent.

Call Forwarding

Toggles Call Forwarding on or off.

Call Log

Selects the call log list.

Channel Announcement

Plays zone and channel announcement voice messages for the current channel.

Emergency

Depending on the programming, initiates or cancels an emergency.

Intelligent Audio

Toggles intelligent audio on or off.

Manual Site Roam ³

Starts the manual site search.

³ Not applicable in Capacity Plus.

Mic AGC

Toggles the internal microphone automatic gain control (AGC) on or off.

Monitor

Monitors a selected channel for activity.

Notifications

Provides direct access to the Notifications list.

Nuisance Channel Delete³

Temporarily removes an unwanted channel, except for the Selected Channel, from the scan list. The Selected Channel refers to the selected zone or channel combination of the user from which scan is initiated.

One Touch Access 

Directly initiates a predefined Private, Phone or Group Call, a Call Alert, a Quick Text message, or Home Revert.

Permanent Monitor³

Monitors a selected channel for all radio traffic until function is disabled.

Phone 

Provides direct access to the Phone Contacts list.

Privacy 

Toggles privacy on or off.

Radio Alias and ID

Provides radio alias and ID.

Radio Check 

Determines if a radio is active in a system.

Radio Enable 

Allows a target radio to be remotely enabled.

Radio Disable 

Allows a target radio to be remotely disabled.

Repeater/Talkaround³

Toggles between using a repeater and communicating directly with another radio.

Reset Home Channel

Sets a new home channel.

Silence Home Channel Reminder

Mutes the Home Channel Reminder.

Scan ⁴

Toggles scan on or off.

⁴ Not applicable in Capacity Plus–Single-Site.

Site Lock³

When toggled on, the radio searches the current site only. When toggled off, the radio searches other sites in addition to the current site.

Text Message

Selects the text message menu.

Transmit Interrupt Remote Dekey

Stops an ongoing interruptible call to free the channel.

Trill Enhancement

Toggles trill enhancement on or off.

Voice Announcement On/Off

Toggles voice announcement on or off.

Voice Operating Transmission (VOX)

Toggles VOX on or off.

Zone Selection

Allows selection from a list of zones.

3.1.2

Assignable Settings or Utility Functions

The following radio settings or utility functions can be assigned to the programmable buttons.

Tones/Alerts

Toggles all tones and alerts on or off.

Backlight

Toggles display backlight on or off.

Backlight Brightness

Adjusts the brightness level.

Power Level



Toggles transmit power level between high and low.

3.1.3



Accessing Programmed Functions

Follow the procedure to access programmed functions in your radio.

- 1 Do one of the following:
 - Press the programmed button. Proceed to [step 3](#).
 - Press  to access the menu.

- 2 Press  or  to the menu function, and press  to select a function or enter a sub-menu.

- 3 Do one of the following:

- Press  to return to the previous screen.
- Long press  to return to the Home screen.

Your radio automatically exits the menu after a period of inactivity and returns to the Home screen.

your call) releases the **PTT** button, indicating the channel is free for you to respond.

 You hear a continuous Talk Prohibit Tone if your call is interrupted. You should release the **PTT** button if you hear a continuous Talk Prohibit Tone.

3.2

Push-To-Talk Button

The Push-to-Talk (**PTT**) button serves two basic purposes:

- While a call is in progress, the **PTT** button allows the radio to transmit to other radios in the call. The microphone is activated when the **PTT** button is pressed.
- While a call is not in progress, the **PTT** button is used to make a new call (see [Calls on page 38](#)).

Long press the **PTT** button to talk. Release the **PTT** button to listen.

If the Talk Permit Tone or the PTT Sidetone  is enabled, wait until the short alert tone ends before talking.

 If the Channel Free Indication feature is enabled on your radio (programmed by your dealer), you hear a short alert tone the moment the target radio (the radio that is receiving

Status Indicators

This chapter explains the status indicators and audio tones used in the radio.

4.1

Icons







The following icons appear on the status bar at the top of the radio display.









Table 2: Display Icons

The icons are arranged left most in order of appearance or usage.

	<p>Battery</p> <p>The number of bars (0–4) shown indicates the charge remaining in the battery. The icon blinks when the battery bar is at 0.</p>
	<p>Bluetooth Connected</p> <p>The Bluetooth feature is enabled. The icon stays lit when a remote Bluetooth device is connected.</p>

	<p>Bluetooth Not Connected</p> <p>The Bluetooth feature is enabled but there is no remote Bluetooth device connected.</p>
	<p>Emergency</p> <p>Radio is in Emergency mode.</p>
	<p>Flexible Receive List</p> <p>Flexible receive list is enabled.</p>
	<p>High Volume Data</p> <p>Radio is receiving high volume data and channel is busy.</p>
	<p>Monitor</p> <p>Selected channel is being monitored.</p>
	<p>Mute Mode</p> <p>Mute Mode is enabled and speaker is muted.</p>
	<p>Notification</p> <p>Notification List has one or more missed events.</p>

	Over-the-Air Programming Delay Timer Indicates time left before automatic re-start of radio.
	Power High Radio is set at High power.
	Power Low Radio is set at Low power.
	Received Signal Strength Indicator (RSSI) The number of bars displayed represents the radio signal strength. Four bars indicate the strongest signal. This icon is only displayed while receiving.
	Response Inhibit Response Inhibit is enabled.
	Ring Only Ringing mode is enabled.
	Scan Scan feature is enabled.

	Scan-Priority 1 Radio detects activity on channel/group designated as Priority 1.
	Scan-Priority 2 Radio detects activity on channel/group designated as Priority 2.
	Secure The Privacy feature is enabled.
	Site Roaming The site roaming feature is enabled.
	Talkaround In the absence of a repeater, radio is configured for direct radio-to-radio communication.
	Tones Disable Tones are turned off.
	Unsecure The Privacy feature is disabled.
	Vote Scan Vote scan feature is enabled.







	Wi-Fi Excellent Wi-Fi signal is excellent.
	Wi-Fi Good Wi-Fi signal is good.
	Wi-Fi Average Wi-Fi signal is average.
	Wi-Fi Poor Wi-Fi signal is poor.
	Wi-Fi Unavailable Wi-Fi signal is unavailable.

Table 3: Call Icons

The following icons appear on the display during a call. These icons also appear in the Contacts list to indicate alias or ID type.

	Private Call Indicates a Private Call in progress. In the Contacts list, it indicates a subscriber alias (name) or ID (number).
---	---





	Group Call/All Call Indicates a Group Call or All Call in progress. In the Contacts list, it indicates a group alias (name) or ID (number).
	Phone Call as Group/All Call Indicates a Phone Call as Group Call or All Call in progress. In the Contacts list, it indicates a group alias (name) or ID (number).
	Phone Call as Private Call Indicates a Phone Call as Private Call in progress. In the Contacts list, it indicates a phone alias (name) or ID (number).

Table 4: Advance Menu Icons

The following icons appear beside menu items that offer a choice between two options or as an indication that there is a sub-menu offering two options.

	Checkbox (Checked) Indicates that the option is selected.
---	---





	<p>Checkbox (Empty) Indicates that the option is not selected.</p>
	<p>Solid Black Box Indicates that the option selected for the menu item with a sub-menu.</p>

Table 5: Bluetooth Device Icons

The following icons appear next to items in the list of Bluetooth-enabled devices available to indicate the device type.

	<p>Bluetooth Audio Device Bluetooth-enabled audio device, such as a headset.</p>
	<p>Bluetooth Data Device Bluetooth-enabled data device, such as a scanner.</p>
	<p>Bluetooth PTT Device Bluetooth-enabled PTT device, such as a PTT-Only Device (POD).</p>



	<p>Bluetooth Sensor Device Bluetooth-enabled sensor device, such as gas sensor.</p>
---	--

Table 6: Mini Notice Icons

The following icons appear momentarily on the display after an action to perform a task is taken.

	<p>Failed Transmission (Negative) Failed action taken.</p>
	<p>Successful Transmission (Positive) Successful action taken.</p>



Transmission in Progress (Transitional)

Transmitting. This is seen before indication for Successful Transmission or Failed Transmission.



Sent Successfully

The text message has been successfully sent.

Table 7: Sent Items Icons

The following icons appear at the top right corner of the display in the Sent Items folder.



In Progress

The text message to a subscriber alias or ID is pending transmission, followed by waiting for acknowledgment. The text message to a group alias or ID is pending transmission.



Send Failed

The text message cannot be sent.

4.2

LED Indicators

LED indicators show the operational status of your radio.

Solid Red

Radio is charging.

Blinking Red

Radio has failed the self-test upon powering up.

Radio is receiving an emergency transmission.

Radio is transmitting in low battery state.

Radio has moved out of range if Auto-Range Transponder System is configured.

Radio encounters charging errors.

Mute Mode is enabled.

Solid Green

Radio is powering up.

Radio is transmitting.

Radio is sending a Call Alert or an emergency transmission.

Blinking Green

Radio is receiving a call or data.

Radio is retrieving Over-the-Air Programming transmissions.

Radio is detecting activity over the air.

Radio is turned on and idle.



NOTICE:

This activity may or may not affect the programmed channel of the radio due to the nature of the digital protocol.

Double Blinking Green

Radio is receiving a privacy-enabled call or data.

Solid Yellow

Radio is monitoring a conventional channel.

Blinking Yellow

Radio is scanning for activity.

Radio has yet to respond to a Call Alert.

Radio has Flexible Receive List enabled.

All Capacity Plus–Multi-Site channels are busy.

Double Blinking Yellow

Radio has Auto Roaming enabled.

Radio is actively searching for a new site.

Radio has yet to respond to a Group Call Alert.

Radio is locked.

Radio is not connected to the repeater while in Capacity Plus.

All Capacity Plus channels are busy.

4.3

Tones

The following are the tones that sound through on the radio speaker.



High Pitched Tone



Low Pitched Tone

4.3.1

Audio Tones

Audio tones provide you with audible indications of the status, or response to data received on the radio.

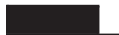

Continuous Tone

A monotone sound. Sounds continuously until termination.



Periodic Tone

Sounds periodically depending on the duration set by the radio. Tone starts, stops, and repeats itself.



Repetitive Tone

A single tone that repeats itself until it is terminated by the user.



Momentary Tone

Sounds once for a short duration set by the radio.

4.3.2

Indicator Tones

Indicator tones provide you with audible indications of the status after an action to perform a task is taken.



Positive Indicator Tone



Negative Indicator Tone

Zone and Channel Selections

This chapter explains the operations to select a zone or channel on your radio. A zone is a group of channels.



Your radio supports up to 128 channels and 50 zones, with a maximum of 16 channels per zone.



Each channel can be programmed with different features and/or support different groups of users.

5.1 Selecting Zones

Follow the procedure to select the required zone on your radio.

- 1 Do one of the following:
 - Press the programmed **Zone Selection** button. Proceed to [step 3](#).
 - Press  to access the menu.
-

- 2 Press  or  to Zone. Press  to select.
The display shows ✓ and the current zone.
-

- 3 Press  or  to the required zone. Press  to select.
The display shows <Zone> Selected momentarily and returns to the selected zone screen.
-

5.2 Selecting Channels

Follow the procedure to select the required channel on your radio.

Push the **Channel Rocker** to select the channel.



NOTICE:

If **Virtual Channel Stop** is enabled, your radio stops proceeding beyond the first or the last channel, and a tone is heard.

The radio displays the current channel and plays the channel announcement voice message.

Calls

This chapter explains the operations to receive, respond to, make, and stop calls.

You can select a subscriber alias or ID, or group alias or ID after you have selected a channel by using one of these features:

Alias Search

This method is used for Group, Private, and All Calls only with a keypad microphone.

Contacts List

This method provides direct access to the Contacts list.

Manual Dial (by using Contacts)

This method is used for Private and Phone Calls only with a keypad microphone.

Programmed Number Keys

This method is used for Group, Private, and All Calls only with a keypad microphone.



NOTICE:

You can only have one alias or ID assigned to a number key, but you can have more than one number key associated to an alias or ID. All the number keys on a keypad microphone can be assigned. See [Assigning Entries to Programmable Number Keys](#) for more information.

Programmed One Touch Access Button

This method is used for Group, Private, and Phone Calls only.

You can only have one ID assigned to a **One Touch Access** button with a short or long programmable button press. Your radio can have multiple **One Touch Access** buttons programmed.

Programmable Button

This method is used for Phone Calls only.

6.1

Group Calls

Your radio must be configured as part of a group to receive a call from or make a call to the group of users.

6.1.1

Making Group Calls

Follow the procedure to make Group Calls on your radio.

- 1 Do one of the following:
 - Select a channel with the active group alias or ID.
 - Press the programmed **One Touch Access** button.
-

- 2 Press the **PTT** button to make the call.
The green LED lights up. The display shows the **Group Call** icon and the group call alias.
-

- 3 Release the **PTT** button to listen.
The green LED lights up when the target radio responds. The display shows the **Group Call** icon, the group alias or ID, and the transmitting radio alias or ID.
-

- 4  If the Channel Free Indication feature is enabled, you hear a short alert tone the moment the transmitting radio releases the **PTT** button, indicating

the channel is free for you to respond. Press the **PTT** button to respond to the call.

The call ends when there is no voice activity for a predetermined period. The radio returns to the screen you were on prior to initiating the call.

6.1.2



Responding to Group Calls

To receive a call from a group of users, your radio must be configured as part of that group. Follow the procedure to respond to Group Calls on your radio.

When you receive a Group Call:

- The green LED blinks.
- The display shows the **Group Call** icon at the top right corner.
- The first text line shows the caller alias.
- The second text line displays the group call alias.
- Your radio unmutes and the incoming call sounds through the speaker.

- 1 Do one of the following:

-  If the Channel Free Indication feature is enabled, you hear a short alert tone the moment the transmitting radio releases the **PTT** button, indicating the channel is free for you to respond. Press the **PTT** button to respond to the call.
-  If the Voice Interrupt feature is enabled, press the **PTT** button to interrupt the audio from the transmitting radio and free the channel for you to respond.

The green LED lights up.

2 Do one of the following:

- Wait for the Talk Permit Tone to end and speak clearly into the microphone if enabled.
-  Wait for the **PTT** Sidetone to end and speak clearly into the microphone if enabled.

3 Release the **PTT** button to listen.

The call ends when there is no voice activity for a predetermined period.

If the radio receives a Group Call while not on the Home screen, it remains on its current screen prior to answering the call.

Long press  to return to the Home screen to view the caller alias before replying.

6.2

Private Calls

A Private Call is a call from an individual radio to another individual radio.

There are two ways to set up a Private Call. The first type sets up the call after performing a radio presence check, while the second type sets up the call immediately. Only one of these types can be programmed to your radio by your dealer.

6.2.1

Making Private Calls

Your radio must be programmed to initiate a Private Call. If this feature is not enabled, a negative indicator tone sounds when you initiate the call. Follow the procedure to make Private Calls on your radio.

1 Do one of the following:

- Select a channel with the active subscriber alias or ID.
- Press the programmed **One Touch Access** button.

2 Press the **PTT** button to make the call.

The green LED lights up. The display shows the **Private Call** icon and the private call alias.

3 Wait for the Talk Permit Tone to end and speak clearly into the microphone if enabled.

4 Release the **PTT** button to listen.

The green LED blinks when the target radio responds.

5 If the Channel Free Indication feature is enabled, you hear a short alert tone the moment the transmitting radio releases the **PTT** button, indicating the channel is free for you to respond. Press the **PTT** button to respond to the call.

The call ends when there is no voice activity for a predetermined period. The display shows **Call Ended**.

6.2.2

Responding to Private Calls

Follow the procedure to respond to Private Calls on your radio.

When you receive a Private Call:

- The green LED blinks.
- The first text line shows the **Private Call** icon.
- The second text line displays the Private Call alias.
- Your radio unmutes and the incoming call sounds through the speaker.

1 Do one of the following:

-  If the Channel Free Indication feature is enabled, you hear a short alert tone the moment the transmitting radio releases the **PTT** button, indicating the channel is free for you to respond. Press the **PTT** button to respond to the call.

-  If the Transmit Interrupt Remote Dekey feature is enabled, press the **PTT** button to stop an ongoing interruptible call and free the channel for you to respond.

The green LED lights up.

- 2 Wait for the Talk Permit Tone to end and speak clearly into the microphone if enabled.
-

- 3 Release the **PTT** button to listen.

The call ends when there is no voice activity for a predetermined period. The display shows **Call Ended**.

6.3

All Calls

An All Call is a call from an individual radio to every radio on the channel. An All Call is used to make important announcements, requiring full attention from the user. The users on the channel cannot respond to an All Call.

6.3.1

Making All Calls

Your radio must be programmed for you to make an All Call. Follow the procedure to make All Calls on your radio.

- 1 Select a channel with the active All Call group alias or ID.
-

- 2 Press the **PTT** button to make the call.

The green LED lights up. The display shows the **All Call** icon and **All Call**.

- 3 Do one of the following:

- Wait for the Talk Permit Tone to end and speak clearly into the microphone if enabled.
-  Wait for the **PTT Sidetone** to end and speak clearly into the microphone if enabled.

Users on the channel cannot respond to an All Call.

6.3.2

Receiving All Calls

When you receive an All Call:

- A tone sounds.

- The green LED blinks.
- The display shows the caller ID information at the top right corner.
- The first text line shows the **Group Call** icon and All Call.
- Your radio unmutes and the incoming call sounds through the speaker.

The radio returns to the screen before receiving the All Call when the call ends.

An All Call does not wait for a predetermined period before ending.

 If the Channel Free Indication feature is enabled, you hear a short alert tone when the transmitting radio releases the **PTT** button, indicating the channel is free for you to use.

You cannot respond to an All Call.



NOTICE:

The radio stops receiving the All Call if you switch to a different channel while receiving the call.

Selective Calls

A Selective Call is a call from an individual radio to another individual radio. It is a Private Call on an analog system.

6.4.1

Making Selective Calls

Your radio must be programmed for you to initiate a Selective Call. Follow the procedure to make Selective Calls on your radio.

- 1 Select a channel with the active subscriber alias or ID.

- 2 Press the **PTT** button to make the call.
The green LED lights up. The display shows the **Private Call** icon, the subscriber alias, and call status.

- 3 Do one of the following:
 - Wait for the Talk Permit Tone to end and speak clearly into the microphone if enabled.

-  Wait for the **PTT** Sidetone to end and speak clearly into the microphone if enabled.
-

4 Release the **PTT** button to listen.

The green LED lights up when the target radio responds.

- #### 5 If the Channel Free Indication feature is enabled, you hear a short alert tone the moment the transmitting radio releases the **PTT** button, indicating the channel is free for you to respond. Press the **PTT** button to respond to the call.

The call ends when there is no voice activity for a predetermined period.

- #### 6 The display shows `Call Ended`.
-

- The first text line shows the **Private Call** icon and the caller alias or `Selective Call` or `Alert with Call`.
- Your radio unmutes and the incoming call sounds through the speaker.

- #### 1 Press the **PTT** button to respond to the call.

The green LED lights up.

- #### 2 Wait for the Talk Permit Tone to end and speak clearly into the microphone if enabled.
-

- #### 3 Release the **PTT** button to listen.

The call ends when there is no voice activity for a predetermined period. A tone sounds. The display shows `Call Ended`.

6.4.2

Responding to Selective Calls

Follow the procedure to respond to Selective Calls on your radio.

When you receive a Selective Call:

- The green LED blinks.

6.5

Phone Calls

A Phone Call is a call from an individual radio to a telephone.

If Phone Call capability is not enabled in your radio:

- The display shows `Unavailable`.

- Your radio mutes the call.
- Your radio returns to the previous screen when the call ends.

During the Phone Call, your radio attempts to end the call when:

- You press the **One Touch Access** button with the deaccess code preconfigured.
- You enter the deaccess code as the input for extra digits.

During channel access, access or deaccess code, or extra digits transmission, your radio responds to the **On/Off** button, **Volume** button, and the **Channel Rocker** only. A tone sounds for every invalid input.

During channel access, press  to dismiss the call attempt. A tone sounds.



NOTICE:

The access or deaccess code cannot be more than 10 characters.

Check with your dealer or system administrator for more information.

6.5.1

Making Phone Calls

Follow the procedure to make Phone Calls on your radio.

- 1 Press the programmed **One Touch Access** button to the predefined alias or ID.

If the entry for the **One Touch Access** button is empty, a negative indicator tone sounds. If the access code is not preconfigured in the Contact List, the display shows `Access Code!`.

- 2 Enter the access code, and press  to proceed.

The green LED lights up. The display shows the **Phone Call** icon at the top right corner. The first text line shows the subscriber alias. The second text line shows the call status.

If the call is successful:

- The DTMF Tone sounds.
- You hear the dialing tone of the telephone user.

If the call is unsuccessful:

- A tone sounds.
- The display shows `Phone Call Failed` and then, `Access Code!`.

- If the access code has been preconfigured in the Contacts list, your radio returns to the screen you were on before initiating the call.

3 Press the **PTT** button to respond to the call. Release the **PTT** button to listen.

4 Press  to end the call.

5 Do one of the following:

- If the deaccess code was not preconfigured, enter the deaccess code when the display shows De-Access Code:, and press  to proceed. The radio returns to the previous screen.
- Press the programmed **One Touch Access** button.
If the entry for the **One Touch Access** button is empty, a negative indicator tone sounds.

The DTMF Tone sounds and the display shows

Ending Phone Call.

If the call ends successfully:

- A tone sounds.
- The display shows Call Ended.



If the call fails to end, the radio returns to the Phone Call screen. Repeat the last two steps or wait for the telephone user to end the call.

6.5.2

Making Phone Calls with the Programmable Phone Button

Follow the procedure to make a phone call with the programmable phone button.

1 Press the programmed **Phone** button to enter into the Phone Entry list.

2 Press  or  to the required alias or ID. Press  to select.

- The green LED lights up. The **Phone Call** icon appears in the top right corner. The first text line shows the subscriber alias. The second text line displays the call status.
- If the call-setup is successful, the Dual Tone Multi Frequency (DTMF) tone sounds. You hear the dialing tone of the telephone user. The first text

line shows the subscriber alias. The **Phone Call** icon remains in the top right corner.

- If call-setup is unsuccessful, a tone sounds and the display shows `Phone Call Failed`. Your radio returns to the Access Code input screen. If the access code was preconfigured in the Contacts list, the radio returns to the screen you were on prior to initiating the call.

3 Press the **PTT** button to talk. Release the **PTT** button to listen.

4 To enter extra digits, if requested by the Phone Call:

- Press **One Touch Access** button. If the entry for the **One Touch Access** button is empty, a negative indicator tone sounds.

5 Press  to end the call.

- The display shows `Ending Phone Call`.
- If the end-call-setup is successful, a tone sounds and the display shows `Call Ended`.

- If the end-call-setup is unsuccessful, your radio returns to the Phone Call screen. Repeat [step 5](#) or wait for the telephone user to end the call.
- When you press **PTT** button while in the Phone Contacts screen, a tone sounds and the display shows `Press OK to Place Phone Call`.
- When the telephone user ends the call, a tone sounds and the display shows `Phone Call Ended`.
- If the call ends while you are entering the extra digits requested by the Phone Call, your radio returns to the screen you were on prior to initiating the call.



NOTICE:

During channel access, press  to dismiss the call attempt and a tone sounds.

During the call, when you press **One Touch Access** button with the deaccess code preconfigured or enter the deaccess code as the input for extra digits, your radio attempts to end the call.

6.5.3

Responding to Phone Calls as Group Calls

Follow the procedure to respond to Phone Calls as Group Calls on your radio.

When you receive a Phone Call as a Group Call:

- The display shows the **Phone Call** icon at the top right corner.
- The display shows the group alias and `Phone Call`.

If Phone Call capability is not enabled on your radio, the first line of the display shows `Unavailable` and your radio mutes the call. Your radio returns to the previous screen when the call ends.

- 1 Press the **PTT** button to respond to the call. Release the **PTT** button to listen.
-

- 2 Press  to end the call.

The display shows `Ending Phone Call`.

If the call ends successfully:

- A tone sounds.
- The display shows `Call Ended`.

If the call fails to end, the radio returns to the Phone Call screen. Repeat this step or wait for the telephone user to end the call.

6.5.4

Responding to Phone Calls as Private Calls

Follow the procedure to respond to Phone Calls as Private Calls on your radio.

When you receive a Phone Call as a Private Call:

- The display shows the **Phone Call** icon at the top right corner.
- The display shows the caller alias or `Phone Call`.

If Phone Call capability is not enabled on your radio, the first line of the display shows `Unavailable` and your radio mutes the call. Your radio returns to the previous screen when the call ends.

- 1 Press the **PTT** button to respond to the call. Release the **PTT** button to listen.
-

- 2 Press  to end the call.

The display shows `Ending Phone Call`.

If the call ends successfully:

- A tone sounds.
- The display shows `Call Ended`.

If the call fails to end, the radio returns to the Phone Call screen. Repeat this step or wait for the telephone user to end the call.

6.5.5

Responding to Phone Calls as All Calls



When you receive a Phone Call as an All Call, you can respond to or end the call, only if an All Call type is assigned to the channel. Follow the procedure to respond to Phone Calls as All Calls on your radio.

When you receive a Phone Call as an All Call:

- The display shows the **Phone Call** icon at the top right corner.
- The display shows `All Call` and `Phone Call`.

If Phone Call capability is not enabled on your radio, the first line of the display shows `Unavailable` and your radio mutes the call.

Your radio returns to the previous screen when the call ends.

- 1 Press the **PTT** button to respond to the call.
-

- 2 Release the **PTT** button to listen.
-

- 3 Press  to end the call.

The display shows `Ending Phone Call`.

If the call ends successfully:

- A tone sounds.
- The display shows `All Call` and `Call Ended`.

If the call fails to end, the radio returns to the Phone Call screen. Repeat [step 3](#) or wait for the telephone user to end the call.

6.6

Initiating Transmit Interrupt

An ongoing call is interrupted, when you perform the following actions:

- Press the **Voice PTT** button.
 - Press the **Emergency** button.
 - Perform data transmission.
-

6.7

Broadcast Voice Calls

A Broadcast Voice Call is a one-way voice call from any user to an entire talkgroup.

The Broadcast Voice Call feature allows only the call initiating user to transmit to the talkgroup, while the recipients of the call cannot respond (no Call Hang Time).

Your radio must be programmed to allow you to use this feature. Check with your dealer or system administrator for more information.

6.7.1

Making Broadcast Voice Calls

Program your radio to make Broadcast Voice Calls.

- 1** Select a channel with the active group alias or ID.

- 2** Press the **PTT** button to make the call.
The green LED lights up.

- 3** Do one of the following:
 - Wait for the Talk Permit Tone to end and speak clearly into the microphone if enabled.
 - Wait for the **PTT** Sidetone to end and speak clearly into the microphone if enabled.

**NOTICE:**

Users on the channel cannot respond to Broadcast Voice Calls.

The radio returns to the previous menu after the call ends.

6.7.2

Receiving Broadcast Voice Calls

When you receive a Broadcast Voice Call:

- A tone sounds.
- The green LED blinks.
- The display shows the caller ID information in the top right corner.
- The first text line shows the **Group Call** icon and `Broadcast Call`.
- Your radio unmutes and the incoming call sounds through the speaker.

When the call ends, the radio returns to the previous screen.

A Broadcast Voice Call does not wait for a predetermined period before ending.

You cannot respond to a Broadcast Voice Call.



NOTICE:

The radio stops receiving the Broadcast Voice Call if you switch to a different channel while receiving the call.

6.8

Unaddressed Calls

An Unaddressed Call is a group call to one of the 16 predefined group IDs.

This feature is configured using CPS-RM. A contact for one of the predefined IDs is required to initiate and/or receive an Unaddressed Call. Check with your dealer or system administrator for more information.

6.8.1

Making Unaddressed Calls

- 1 Select a channel with the active group alias or ID.
-

- 2 Press the **PTT** button to make the call.
The green LED lights up.
-

- 3 Release the **PTT** button to listen.
The green LED lights up when the target radio responds. A momentary tone sounds.
-

- 4 If the Channel Free Indication feature is enabled, you hear a short alert tone the moment the transmitting radio releases the **PTT** button, indicating that the channel is free for you to respond. Press the **PTT** button to respond to the call.

The call ends when there is no voice activity for a predetermined period.

6.8.2

Responding to Unaddressed Calls

When you receive an Unaddressed Call:

- The green LED blinks.
- A momentary tone sounds.
- Your radio unmutes and the incoming call sounds through the speaker.

1 Do one of the following:

- If the Channel Free Indication feature is enabled, you hear a short alert tone the moment the transmitting radio releases the **PTT** button, indicating the channel is free for you to respond. Press the **PTT** button to respond to the call.
- If the Voice Interrupt feature is enabled, press the **PTT** button to interrupt the audio from the transmitting radio and free the channel for you to respond.

The green LED lights up.

2 Do one of the following:

- Wait for the Talk Permit Tone to end and speak clearly into the microphone if enabled.
 - Wait for the **PTT** Sidetone to end and speak clearly into the microphone if enabled.
-

3 Release the **PTT** button to listen.

The call ends when there is no voice activity for a predetermined period.

6.9

Open Voice Channel Mode (OVCM)

An Open Voice Channel Mode (OVCM) allows a radio that is not preconfigured to work in a particular system to both receive and transmit during a group or individual call.

The OVCM group call also supports broadcast calls. Program your radio to use this feature. Check with your dealer or system administrator for more information.

6.9.1

Making OVCM Calls

Your radio must be programmed for you to make an OVCM Call. Follow the procedure to make OVCM Calls on your radio.

1 Select a channel with the active group alias or ID.

2 Press the **PTT** button to make the call.

The green LED lights up.

3 Do one of the following:

- Wait for the Talk Permit Tone to end and speak clearly into the microphone if enabled.
 - Wait for the **PTT** Sidetone to end and speak clearly into the microphone if enabled.
-

6.9.2

Responding to OVCM Calls

When you receive an OVCM Call:

- The green LED blinks.

- Your radio unmutes and the incoming call sounds through the speaker.

1 Do one of the following:

- If the Channel Free Indication feature is enabled, you hear a short alert tone the moment the transmitting radio releases the **PTT** button, indicating the channel is free for you to respond. Press the **PTT** button to respond to the call.
- If the Voice Interrupt feature is enabled, press the **PTT** button to interrupt the audio from the transmitting radio and free the channel for you to respond.

The green LED lights up.

2 Do one of the following:

- Wait for the Talk Permit Tone to end and speak clearly into the microphone if enabled.
 - Wait for the **PTT** Sidetone to end and speak clearly into the microphone if enabled.
-

3 Release the **PTT** button to listen.

The call ends when there is no voice activity for a predetermined period.

Advanced Features

This chapter explains the operations of the features available in your radio.

Your dealer or system administrator may have customized your radio for your specific needs. Check with your dealer or system administrator for more information.

7.1

Bluetooth®

This feature allows you to use your radio with a Bluetooth-enabled device (accessory) through a Bluetooth connection. Your radio supports both Motorola Solutions and Commercially available Off-The-Shelf (COTS) Bluetooth-enabled devices.

Bluetooth operates within a range of 10 m (32ft) line of sight. This is an unobstructed path between your radio and your Bluetooth-enabled device. For high degree of reliability, Motorola Solutions recommends to not separate the radio and the accessory.

At the fringe areas of reception, both voice and tone quality start to sound "garbled" or "broken". To correct this problem, position your radio and Bluetooth-enabled device

closer to each other (within the 10 m defined range) to re-establish clear audio reception. The Bluetooth function of your radio has maximum power of 2.5 mW (4 dBm) at the 10 m range.

Your radio can support up to three simultaneous Bluetooth connections with Bluetooth-enabled devices of unique types. For example, a headset, a scanner, a sensor device, and a PTT-Only Device (POD).

Refer to the user manual of your respective Bluetooth-enabled device for more details on the full capabilities of your Bluetooth-enabled device.



Your radio connects to the Bluetooth-enabled device within range with either the strongest signal strength, or to one which it has connected to before in a prior session. Do not turn off your Bluetooth-enabled device or press the home back button during the finding and connecting operation as this cancels the operation.



7.1.1

Turning Bluetooth On and Off

Follow the procedure to turn Bluetooth on and off.







- 1 Press  to access the menu.

2 Press  or  to Bluetooth. Press  to select.

3 Press  or  to My Status. Press  to select.

The display shows On and Off. The current status is indicated by a ✓.

4 Do one of the following:

- Press  or  to On. Press  to select. The display shows ✓ beside On.
 - Press  or  to Off. Press  to select. The display shows ✓ beside Off.
-



7.1.2

Connecting to Bluetooth Devices

Follow the procedure to connect to Bluetooth devices.









Turn on your Bluetooth-enabled device and place it in pairing mode.

1 Press  to access the menu.

2 Press  or  to Bluetooth. Press  to select.

3 Press  or  to Devices. Press  to select.

4 Do one of the following:

- Press  or  to the required device. Press  to select.
 - Press  or  to Find Devices to locate available devices. Press  or  to the required device. Press  to select.
-

5 Press  or  to Connect. Press  to select.

Your Bluetooth-enabled device may require additional steps to complete the pairing. Refer to the user manual of your Bluetooth-enabled device.

The display shows `Connecting to <Device>`.

Wait for acknowledgment.

If successful:

- A positive indicator tone sounds.
- The display shows `<Device> Connected` and the **Bluetooth Connected** icon.
- The display shows ✓ beside the connected device.

If unsuccessful:







- A negative indicator tone sounds.
- The display shows `Connecting Failed`.

7.1.3

Connecting to Bluetooth Devices in Discoverable Mode

Follow the procedure to connect to Bluetooth devices in discoverable mode.

Turn on your Bluetooth-enabled device and place it in pairing mode.

- 1 Press  to access the menu.
- 2 Press  or  to Bluetooth. Press  to select.
- 3 Press  or  to Find Me. Press  to select. The radio can now be found by other Bluetooth-enabled devices for a programmed duration. This is called Discoverable Mode.

Wait for acknowledgment.

If successful:

- A positive indicator tone sounds.
- The display shows `<Device> Connected` and the **Bluetooth Connected** icon.
- The display shows ✓ beside the connected device.

If unsuccessful:



- A negative indicator tone sounds.
- The display shows `Connecting Failed`.



7.1.4



Disconnecting from Bluetooth Devices



Follow the procedure to disconnect from Bluetooth devices.

- 1 Press  to access the menu.

- 2 Press  or  to Bluetooth. Press  to select.

- 3 Press  or  to Devices. Press  to select.

- 4 Press  or  to the required device. Press  to select.

- 5 Press  or  to Disconnect. Press  to select.
The display shows Disconnecting from <Device>.

Wait for acknowledgment.

- A tone sounds.

- The display shows <Device> Disconnected and the **Bluetooth Connected** icon disappears.
- The ✓ disappears beside the connected device.

7.1.5

Switching Audio Route between Internal Radio Speaker and Bluetooth Device

Follow the procedure to toggle audio routing between internal radio speaker and external Bluetooth device.

Press the programmed **Bluetooth Audio Switch** button.

The display shows one of the following results:



- A tone sounds. The display shows Route Audio to Radio.
- A tone sounds. The display shows Route Audio to Bluetooth.



7.1.6



Viewing Device Details



Follow the procedure to view device details on your radio.

- 1 Press  to access the menu.

- 2 Press  or  to Bluetooth. Press  to select.

- 3 Press  or  to Devices. Press  to select.

- 4 Press  or  to the required device. Press  to select.



- 5 Press  or  to View Details. Press  to select.



7.1.7



Deleting Device Name



You can remove a disconnected device from the list of Bluetooth-enabled devices.

- 1 Press  to access the menu.

- 2 Press  or  to Bluetooth. Press  to select.

- 3 Press  or  to Devices. Press  to select.

- 4 Press  or  to the required device. Press  to select.



- 5 Press  or  to Delete. Press  to select. The display shows Device Deleted.



7.1.8



Bluetooth Mic Gain



This feature allows the user to control the microphone gain value of the connected Bluetooth-enabled device.

- 1 Press  to access the menu.

2 Press  or  to Bluetooth. Press  to select.

3 Press  or  to BT Mic Gain. Press  to select.

4 Press  or  to the BT Mic Gain type and the current values. Press  to select. You can edit the values here.

5 Press  or  to increase or to decrease values. Press  to select.

7.1.9

Permanent Bluetooth Discoverable Mode

The Permanent Bluetooth Discoverable Mode must be enabled by the dealer or system administrator.



NOTICE:

If enabled, Bluetooth is **not** displayed in the Menu and you cannot use any Bluetooth programmable button features.

Other Bluetooth-enabled devices can locate your radio, but the devices cannot connect to the radio. The Permanent Bluetooth Discoverable Mode enables dedicated devices to use your radio position in the process of Bluetooth-based location.

7.2

Indoor Location



NOTICE:









Indoor Location feature is applicable for models with the latest software and hardware. Check with your dealer or system administrator for more information.

Indoor Location is use to keep track of the location of radio users. When Indoor Location is activated, the radio is in a limited discoverable mode. Dedicated beacons are used to locate the radio and determine its position.

7.2.1

Turning Indoor Location On or Off

You can turn on or turn off Indoor Location by performing one of the following actions.

- Access this feature through the menu.
 - a. Press  to access the menu.
 - b. Press  or  to Bluetooth and press  to select.
 - c. Press  or  to Indoor Location and press  to select.
 - d. Press  to turn on Indoor Location.

The display shows `Indoor Location On`. You hear a positive indicator tone.

One of the following scenarios occurs.

- If successful, the Indoor Location Available icon appears on the Home screen display.

- If unsuccessful, the display shows `Turning On Failed`. You hear a negative indicator tone.

- e. Press  to turn off Indoor Location.

The display shows `Indoor Location Off`. You hear a positive indicator tone.

One of the following scenarios occurs.

- If successful, the Indoor Location Available icon disappears on the Home screen display.
- If unsuccessful, the display shows `Turning Off Failed`. You hear a negative indicator tone.

- Access this feature by using the programmed button.
 - a. Long press the programmed **Indoor Location** button to turn on Indoor Location.

The display shows `Indoor Location On`. You hear a positive indicator tone.

One of the following scenarios occurs.

- If successful, the Indoor Location Available icon appears on the Home screen display.

- If unsuccessful, the display shows **Turning On Failed**. If unsuccessful, you hear a negative indicator tone.
- b. Press the programmed **Indoor Location** button to turn off Indoor Location.

The display shows **Indoor Location Off**. You hear a positive indicator tone. One of the following scenarios occurs.



- If successful, the Indoor Location Available icon disappears on the Home screen display.
- If unsuccessful, the display shows **Turning Off Failed**. If unsuccessful, you hear a negative indicator tone.



7.2.2



Accessing Indoor Location Beacons Information

Follow the procedure to access Indoor Location beacons information.

- 1 Press  to access the menu.

- 2 Press  or  to **Bluetooth** and press  to select.

- 3 Press  or  to **Indoor Location** and press  to select.

- 4 Press  or  to **Beacons** and press  to select.

The display shows the beacons information.

7.3

Talkaround

This feature allows you to continue communicating when your repeater is non-operational, or when your radio is out of range from the repeater but within the talk range of other radios.

The talkaround setting is retained even after powering down.



NOTICE:



This feature is not applicable in Capacity Plus–Single-Site, Capacity Plus–Multi-Site, and Citizens Band channels that are in the same frequency.



7.3.1



Toggling Between Repeater and Talkaround Modes

Follow the procedure to toggle between Repeater and Talkaround modes on your radio.

- 1 Do one of the following:
 - Press the programmed **Repeater/Talkaround** button. Skip the following steps.
 - Press  to access the menu.

- 2 Press  or  to Utilities. Press  to select.

- 3 Press  or  to Radio Settings. Press  to select.

- 4 Press  or  to Talkaround. Press  to select.

If enabled, ✓ appears beside Enabled.

If disabled, ✓ disappears beside Enabled.

The screen automatically returns to the previous screen.

7.4

Monitor Feature

The feature allows you to ensure that a channel is free before transmitting.

7.4.1

Monitoring Channels

Follow the procedure to monitor channels.

- 1 Long press the programmed **Monitor** button.

The **Monitor** icon appears on the display and the LED lights up solid yellow.

If the channel is in use:

If the monitored channel is free, you hear a "white noise".

- 2 Press the **PTT** button to talk. Release the **PTT** button to listen.

7.4.2

Permanent Monitor

The Permanent Monitor feature is used to continuously monitor a selected channel for activity.

7.4.2.1

Turning Permanent Monitor On or Off

Follow the procedure to turn Permanent Monitor on or off on your radio.

Press the programmed **Permanent Monitor** button.

When the radio enters the mode:

- An alert tone sounds.
- The yellow LED lights up.
- The display shows `Permanent Monitor On` and the **Monitor** icon.

When the radio exits the mode:

- An alert tone sounds.
- The yellow LED turns off.
- The display shows `Permanent Monitor Off`.

7.5

Home Channel Reminder

This feature provides a reminder when the radio is not set to the home channel for a period of time.

If this feature is enabled through CPS, when your radio is not set to the home channel for a period of time, the following occurs periodically:

- The Home Channel Reminder tone and announcement sound.
- The first line of the display shows `Non`.
- The second line shows `Home Channel`.

You can respond to the reminder by performing one of the following actions:

- Return to the home channel.
- Mute the reminder temporarily using the programmable button.
- Set a new home channel using the programmable button.

7.5.1

Muting the Home Channel Reminder

When the Home Channel Reminder sounds, you can temporarily mute the reminder.

Press the programmed **Silence Home Channel Reminder** button.



The display shows HCR Silenced.

7.5.2



Setting New Home Channels

When the Home Channel Reminder occurs, you can set a new home channel.

- 1 Do one of the following:
 - Press the **Reset Home Channel** programmable button to set the current channel as the new Home Channel. Skip the following steps. The first line of the display shows the channel alias and the second line shows New Home Ch.
 - Press  to access the menu.
-

- 2 Press  or  to Utilities. Press  to select.
-

- 3 Press  or  to Radio Settings. Press  to select.
-

- 4 Press  or  to Home Channel. Press  to select.
-

- 5 Press  or  to the desired new home channel alias. Press  to select.

The display shows ✓ beside the selected home channel alias.

7.6

Remote Monitor

This feature is used to turn on the microphone of a target radio with a subscriber alias or ID. You can use this feature to remotely monitor any audible activity surrounding the target radio.

There are two types of Remote Monitor:

- Remote Monitor without Authentication
- Remote Monitor with Authentication.

Authenticated Remote Monitor is a purchasable feature. In Authenticated Remote Monitor, verification is required when your radio turns on the microphone of a target radio.

When your radio initiates this feature on a target radio with User Authentication, a passphrase is required. The passphrase is preprogrammed into the target radio through CPS.

Both your radio and the target radio must be programmed to allow you to use this feature.



This feature stops after a programmed duration or when there is any user operation on the target radio.

7.6.1

Initiating Remote Monitor

Follow the procedure to initiate Remote Monitor on your radio.

- 1 Press the programmed **Remote Monitor** button.
-

- 2 Press  or  to the required alias or ID.
-

- 3 Press  to select. One of the following scenarios occurs:

- The display shows a transitional mini notice, indicating the request is in progress. The green LED lights up.
- A passphrase screen appears.

Enter the passphrase. Press  to proceed.

- If the passphrase is correct, the display shows a transitional mini notice, indicating the request is in progress. The green LED lights up.
 - If the passphrase is incorrect, the display shows a negative mini notice, and returns to the previous screen.
-

- 4 Wait for acknowledgment.

If successful:

- A positive indicator tone sounds.
- The display shows a positive mini notice.
- The audio from the monitored radio starts playing for a programmed duration, and the display

shows Rem. Monitor. Once the timer expires, an alert tone sounds, and the LED turns off.







If unsuccessful:

- A negative indicator tone sounds.
- The display shows a negative mini notice.

7.6.2

Initiating Remote Monitor by Using the Contacts List

Follow the procedure to initiate Remote Monitor on your radio by using the Contacts list.

- 1 Press  to access the menu.
- 2 Press  or  to Contacts. Press  to select.
- 3 Press  or  to the required alias or ID. Press  to select.

- 4 Press  or  to Remote Mon..

- 5 Press  to select. One of the following scenarios occurs:

- The display shows a transitional mini notice, indicating the request is in progress. The green LED lights up.
- A passphrase screen appears.

Enter the passphrase. Press  to proceed.

- If the passphrase is correct, the display shows a transitional mini notice, indicating the request is in progress. The green LED lights up.
- If the passphrase is incorrect, the display shows a negative mini notice, and returns to the previous screen.

- 6 Wait for acknowledgment.

If successful:

- A positive indicator tone sounds.
- The display shows a positive mini notice.

- The audio from the monitored radio starts playing for a programmed duration, and the display shows Rem. Monitor. Once the timer expires, an alert tone sounds, and the LED turns off.







If unsuccessful:



- A negative indicator tone sounds.
- The display shows a negative mini notice.

7.6.3



Initiating Remote Monitor by Using the Manual Dial

Follow the procedure to initiate Remote Monitor on your radio by using the manual dial.

- 1 Press  to access the menu.
- 2 Press  or  to Contacts. Press  to select.
- 3 Press  or  to Manual Dial. Press  to select.

- 4 Press  or  to Radio Number. Press  to select.

- 5 Do one of the following:

- Enter the subscriber alias or ID, and press  to proceed.
- Edit the previously dialed ID, and press  to proceed.

- 6 Press  or  to Remote Mon..

- 7 Press  to select. One of the following scenarios occurs:

- The display shows a transitional mini notice, indicating the request is in progress. The green LED lights up.
- A passphrase screen appears.

Enter the passphrase. Press  to proceed.

- If the passphrase is correct, the display shows a transitional mini notice, indicating the

request is in progress. The green LED lights up.

- If the passphrase is incorrect, the display shows a negative mini notice, and returns to the previous screen.

8 Wait for acknowledgment.

If successful:

- A positive indicator tone sounds.
- The display shows a positive mini notice.
- The audio from the monitored radio starts playing for a programmed duration, and the display shows *Rem. Monitor*. Once the timer expires, an alert tone sounds, and the LED turns off.

If unsuccessful:

- A negative indicator tone sounds.
- The display shows a negative mini notice.

Radio Check



This feature allows you to determine if another radio is active in a system without disturbing the radio user. No audible or visual notification is shown on the target radio. This feature is only applicable for subscriber aliases or IDs. Your radio must be programmed to allow you to use this feature.

7.7.1

Sending Radio Checks

Follow the procedure to send radio checks on your radio.

- 1 Press the programmed **Radio Check** button.

- 2 Press  or  to the required alias or ID. Press  to select.

The display shows a transitional mini notice, indicating the request is in progress. The green LED lights up.

Wait for acknowledgment.







If you press  when the radio is waiting for acknowledgment, a tone sounds, the radio terminates all retries, and exits Radio Check mode.



The radio returns to the subscriber alias or ID screen.

7.7.2

Sending Radio Checks by Using the Contacts List

Follow the procedure to send radio checks on your radio by using the Contacts list.

- 1 Press  to access the menu.
- 2 Press  or  to **Contacts**. Press  to select.
- 3 Press  or  to the required alias or ID. Press  to select.

- 4 Press  or  to **Radio Check**. Press  to select.

The green LED lights up.

- 5 Wait for acknowledgment.

If you press  when the radio is waiting for acknowledgement, a tone sounds, the radio terminates all retries, and exits Radio Check mode. The radio returns to the subscriber alias or ID screen.

7.8

Scan Lists

Scan lists are created and assigned to individual channels or groups. Your radio scans for voice activity by cycling through the channel or group sequence specified in the scan list for the current channel or group.

Your radio can support up to 250 scan lists, with a maximum of 16 members in a list.

Each scan list supports a mixture of both analog and digital entries.

You can add, delete, or prioritize channels by editing a scan list.



The **Priority** icon appears on the left of the member alias, if set, to indicate whether the member is on a Priority 1 or Priority 2 channel list. You cannot have multiple Priority 1 or Priority 2 channels in a scan list. There is no **Priority** icon if priority is set to **None**.



7.8.1



Viewing Entries in the Scan List

Follow the procedure to view the entries in the Scan list on your radio.

- 1 Press  **OK** to access the menu.

- 2 Press  or  to Scan. Press  **OK** to select.

- 3 Press  or  to Scan List. Press  **OK** to select.



- 4 Press  or  to view each member on the list.



7.8.2



Adding New Entries to the Scan List



Follow the procedure to add new entries to the Scan list on your radio.



- 1 Press  **OK** to access the menu.

- 2 Press  or  to Scan. Press  **OK** to select.

- 3 Press  or  to Scan List. Press  **OK** to select.







- 4 Press  or  to Add Member. Press  **OK** to select.

- 5 Press  or  to the required alias or ID. Press  **OK** to select.

- 6 Press  or  to the required priority level.
Press  to select.

The display shows a positive mini notice and then,
Add Another?.





- 7 Do one of the following:



- Press  or  to Yes to add another entry.
Press  to select. Repeat [step 5](#) and [step 6](#).
 - Press  or  to No to save the current list. Press  to select.
-



7.8.3

Deleting Entries from the Scan List

Follow the procedure to delete entries from the Scan list.







- 1 Press  to access the menu.
-
- 2 Press  or  to Scan. Press  to select.
-

- 3 Press  or  to Scan List. Press  to select.
-

- 4 Press  or  to the required alias or ID.
Press  to select.
-

- 5 Press  or  to Delete. Press  to select.
The display shows Delete Entry?.
-

- 6 Do one of the following:

- Press  or  to Yes to delete the entry.
Press  to select.
The display shows a positive mini notice.
 - Press  or  to No to return to the previous screen. Press  to select.
-













- 7 Repeat [step 4](#) to [step 6](#) to delete other entries.
-



- 8 Long press  to return to the Home screen after deleting all required aliases or IDs.
-

7.8.4

Setting Priority for Entries in the Scan List

Follow the procedure to set priorities for entries in the Scan list on your radio.

- 1 Press  to access the menu.
-
- 2 Press  or  to Scan. Press  to select.
-
- 3 Press  or  to Scan List. Press  to select.
-
- 4 Press  or  to the required alias or ID. Press  to select.
-
- 5 Press  or  to Edit Priority. Press  to select.
-

- 6 Press  or  to the required priority level. Press  to select.

The display shows a positive mini notice before returning to the previous screen. The **Priority** icon appears on the left of the member alias.

7.9

Scan

Your radio cycles through the programmed scan list for the current channel looking for voice activity when you start a scan.

There are two ways of initiating scan:

Main Channel Scan (Manual)

Your radio scans all the channels or groups in your scan list. On entering scan, your radio may, depending on the settings, automatically start on the last scanned active channel or group, or on the channel where scan was initiated.

Auto Scan (Automatic)

Your radio automatically starts scanning when you select a channel or group that has Auto Scan enabled.



7.9.1



Turning Scan On or Off



Follow the procedure to turn scan on or off on your radio.

- 1 Push the **Channel Rocker** to select a channel programmed with Auto Scan enabled.

- 2 Press  to access the menu.

- 3 Press  or  to Scan. Press  to select.

- 4 Press  or  to Scan State. Press  to select.

- 5 Press  or  to the required scan state and press  to select.

If scan is enabled:

- The display shows Scan On and **Scan** icon.
- The yellow LED blinks.

If scan is disabled:

- The display shows Scan Off.

- The **Scan** icon disappears.
- The LED turns off.

7.9.2

Responding to Transmissions During Scanning

During scanning, your radio stops on a channel or group where activity is detected. The radio stays on that channel for a programmed duration known as hang time. Follow the procedure to respond to transmissions during scanning.

- 1  If the Channel Free Indication feature is enabled, you hear a short alert tone the moment the transmitting radio releases the **PTT** button, indicating the channel is free for you to respond. Press the **PTT** button during hang time.
The green LED lights up.

- 2 Do one of the following:
 - Wait for the Talk Permit Tone to end and speak clearly into the microphone if enabled.

-  Wait for the **PTT** Sidetone to end and speak clearly into the microphone if enabled.

3 Release the **PTT** button to listen.

The radio returns to scanning other channels or groups if you do not respond within the hang time.

7.9.3

Deleting Nuisance Channels

If a channel continually generates unwanted calls or noise, (termed a "nuisance" channel), you can temporarily remove the unwanted channel from the scan list. This capability does not apply to the channel designated as the Selected Channel. Follow the procedure to delete nuisance channels on your radio.

- 1 When your radio locks on to an unwanted or nuisance channel, press the programmed **Nuisance Channel Delete** button until you hear a tone.
- 2 Release the programmed **Nuisance Channel Delete** button.
The nuisance channel is deleted.

7.9.4

Restoring Nuisance Channels

Follow the procedure to restore nuisance channels on your radio.

Do one of the following:

- Turn the radio off and then power it on again.
- Stop and restart a scan using the programmed **Scan** button or menu.
- Change the channel using the **Channel Rocker** button.

7.10

Vote Scan



Vote Scan provides you with wide area coverage in areas where there are multiple base stations transmitting identical information on different analog channels.

Your radio scans analog channels of multiple base stations and performs a voting process to select the strongest received signal. Once that is established, your radio receives transmissions from that base station.

During a vote scan, the yellow LED blinks and the display shows the **Vote Scan** icon.

To respond to a transmission during a vote scan, see [Responding to Transmissions During Scanning on page 74](#).

7.11

Contacts Settings

Contacts provides address book capabilities on your radio. Each entry corresponds to an alias or ID that you use to initiate a call. The entries are alphabetically sorted.

Each entry, depending on context, associates with the different call types: Group Call, Private Call, All Call, PC Call, or Dispatch Call.

PC Call and Dispatch Call are data-related. They are only available with the applications. Refer to the data applications documentation for further details.



NOTICE:

You see a checkmark before each number key that is assigned to an entry. If the checkmark is before `Empty`, you have not assign a number key to the entry.

Your radio supports two Contacts lists, each for Analog contacts and Digital contacts, with a maximum of 500 members for each Contacts list.

Each entry within Contacts displays the following information:

- Call Type
- Call Alias
- Call ID



NOTICE:

You can add, or edit subscriber IDs for the Digital Contacts list. Deleting subscriber IDs can only be performed by your dealer.

You can only view the subscriber IDs, edit the subscriber IDs, and initiate a Call Alert for the Analog Contacts list. Adding and deleting capabilities can only be performed by your dealer.



If the Privacy feature is enabled on a channel, you can make privacy-enabled Group Calls, Private Calls, and All Calls on that channel. Only target radios with the same Privacy Key, or the same Key Value and Key ID as your radio will be able to decrypt the transmission.



7.11.1

Making Group Calls by Using the Contacts List

Follow the procedure to make Group Calls on your radio by using the Contacts list.

- 1 Press  to access the menu.

- 2 Press  or  to `Contacts`. Press  to select.

- 3 Press  or  to the required alias or ID.

- 4 Press the **PTT** button to make the call.
The green LED lights up.

- 5 Do one of the following:
 - Wait for the Talk Permit Tone to end and speak clearly into the microphone if enabled.
 -  Wait for the **PTT** Sidetone to end and speak clearly into the microphone if enabled.

- 6 Release the **PTT** button to listen.

The green LED blinks when any user in the group responds. The display shows the **Group Call** icon, and alias or ID, and the transmitting radio alias or ID.



- 7  If the Channel Free Indication feature is enabled, you hear a short alert tone the moment the transmitting radio releases the **PTT** button, indicating the channel is free for you to respond. Press the **PTT** button to respond to the call.



The call ends when there is no voice activity for a predetermined period.

7.11.2

Making Private Calls by Using the Contacts List

- 1 Press  to access the menu.

- 2 Press  or  to `Contacts`. Press  to select.

- 3 Press  or  to the required alias or ID.
Press  to select.
-

- 4 Press the **PTT** button to make the call.
The green LED lights up. The display shows the destination alias.
-

- 5 Wait for the Talk Permit Tone to end and speak clearly into the microphone if enabled.
-





- 6 Release the **PTT** button to listen.
The display shows the transmitting user alias or ID.
-



- 7  If the Channel Free Indication feature is enabled, you hear a short alert tone the moment the transmitting radio releases the **PTT** button, indicating the channel is free for you to respond. Press the **PTT** button to respond to the call.

The call ends when there is no voice activity for a predetermined period. A tone sounds. The display shows `Call Ended`.

Setting Default Contact

Follow the procedure to set the default contact on your radio.

- 1 Press  to access the menu.
-
- 2 Press  or  to `Contacts`. Press  to select.
-

- 3 Press  or  to the required alias or ID.
Press  to select.
-

- 4 Press  or  to `Set as Default`. Press  to select.

A positive indicator tone sounds. The display shows a positive mini notice. The display shows ✓ beside the selected default alias or ID.

7.12



Call Indicator Settings



This feature allows you to configure call or text message ringing tones.



7.12.1



Activating or Deactivating Call Ringers for Call Alerts



- 1 Press  to access the menu.







- 2 Press  or  to Utilities. Press  to select.

- 3 Press  or  to Radio Settings. Press  to select.

- 4 Press  or  to Tones/Alert. Press  to select.

- 5 Press  or  to Call Ringers. Press  to select.

- 6 Press  or  to Call Alert. Press  to select.



- 7 Do one of the following:
 - Press  or  to the required tone. Press  to select.
The display shows ✓ and the selected tone.
 - Press  or  to Off. Press  to select.
If the ringing tones were earlier enabled, the display shows ✓ beside Off.
If the ringing tones were earlier disabled, the display does not show ✓ beside Off.



7.12.2



Activating or Deactivating Call Ringers for Private Calls



Follow the procedure to activate or deactivate call ringers for Private Calls on your radio.



- 1 Press  to access the menu.

- 2 Press  or  to Utilities. Press  to select.

- 3 Press  or  to Radio Settings. Press  to select.







- 4 Press  or  to Tones/Alerts. Press  to select.

- 5 Press  or  to Call Ringers. Press  to select.

- 6 Press  or  to Private Call. Press  to select.

The display shows ✓ beside On if Private Call ringing tones are enabled.

The display shows ✓ beside Off if Private Call ringing tones are disabled.



- 7 Do one of the following:
 - Press  or  to On. Press  to select. The display shows ✓ beside On.
 - Press  or  to Off. Press  to select. The display shows ✓ beside Off.



7.12.3



Activating or Deactivating Call Ringers for Selective Calls



Follow the procedure to activate or deactivate call ringers for Selective Calls on your radio.



- 1 Press  to access the menu.

- 2 Press  or  to Utilities. Press  to select.







- 3 Press  or  to Radio Settings. Press  to select.

- 4 Press  or  to Tones/Alerts. Press  to select.

- 5 Press  or  to Call Ringers. Press  to select.

- 6 Press  or  to Selective Call. Press  to select.
The display shows ✓ and the current tone.

- 7 Do one of the following:



- Press  or  to the required tone. Press  to select.
The display shows ✓ and the selected tone.
- Press  or  to Off. Press  to select.
If the ringing tones were earlier enabled, the display shows ✓ beside Off.
If the ringing tones were earlier disabled, the display does not show ✓ beside Off.

7.12.4

Activating or Deactivating Call Ringers for Text Messages

Follow the procedure to activate or deactivate call ringers for text messages on your radio.

- 1 Press  to access the menu.

- 2 Press  or  to Utilities. Press  to select.

- 3 Press or to Radio Settings. Press to select.
-

- 4 Press or to Tones/Alerts. Press to select.
-

- 5 Press or to Call Ringers. Press to select.
-

- 6 Press or to Text Message. Press to select.

The display shows ✓ and the current tone.

- 7 Do one of the following:

- Press or to the required tone. Press to select.

The display shows ✓ and the selected tone.

- Press or to Off. Press to select.

If the ringing tones were earlier enabled, the display shows ✓ beside Off.

If the ringing tones were earlier disabled, the display does not show ✓ beside Off.

7.12.5

Assigning Ring Styles

The radio can be programmed to sound one of eleven predefined ringing tones when receiving a Private Call, a Call Alert, or a Text Message from a particular contact. The radio sounds out each ring style as you navigate through the list.

- 1 Press to access the menu.
-

- 2 Press or to Contacts. Press to select.



The entries are alphabetically sorted.

- 3 Press or to the required alias or ID. Press to select.
-

- 4 Press or to View/Edit. Press to select.
-

5 Press  until display shows `Ringer` menu

A ✓ indicates the current selected tone.

6 Press  or  to the required tone. Press  to select.

The display shows `Contact Saved`.

7.12.6

Selecting a Ring Alert Type





NOTICE:

The programmed **Ring Alert Type** button is assigned by your dealer or system administrator. Check with your dealer or system administrator to determine how your radio has been programmed.



You can select a Ring Alert Type by performing one of the following actions.



- Press the programmed **Ring Alert Type** button to access the Ring Alert Type menu.

a. Press  or  to `Ring or Silent` and press  to select.



- Access this feature through the menu.



a. Press  to access the menu.

b. Press  or  to `Utilities` and press  to select.

c. Press  or  to `Radio Settings` and press  to select.

d. Press  or  to `Tones/Alerts` and press  to select.

e. Press  or  to `Ring Alert Type` and press  to select.

f. Press  or  to `Ring or Silent` and press  to select.

7.12.7

Alarm Tone Volume Escalation

Your radio can be programmed by your dealer to continually alert you when a radio call remains unanswered. This is done by automatically increasing the alarm tone volume over time. This feature is known as Escalert.

7.13

Call Log Features

Your radio keeps track of all recent outgoing, answered, and missed Private Calls. The call log feature is used to view and manage recent calls.



Missed Call Alerts may be included in the call logs, depending on the system configuration on your radio. You can perform the following tasks in each of your call lists:



- Delete Call
- View Details

7.13.1

Viewing Recent Calls



- 1 Press  to access the menu.

- 2 Press  or  to Call Log. Press  to select.

- 3 Press  or  to the preferred list. The options are Missed, Answered, and Outgoing lists.

Press  to select.

The display shows the most recent entry.

- 4 Press  or  to view the list.



You can start a call with the alias or ID the display is currently showing by pressing the **PTT** button.



7.13.2



Deleting Calls from the Call List



Follow the procedure to delete calls from the Call list.

- 1 Press  to access the menu.

- 2 Press  or  to Call Log. Press  to select.

- 3 Press  or  to the required list. Press  to select.
If the list is empty:
 - A tone sounds.
 - The display shows List Empty.

- 4 Press  or  to the required alias or ID. Press  to select.

- 5 Press  or  to Delete Entry?. Press  to select.

- 6 Do one of the following:
 - Press  to select Yes to delete the entry. The display shows Entry Deleted.

- Press  or  to No. Press  to select.



The radio returns to the previous screen.



7.13.3



Viewing Call List Details



Follow the procedure to view call details on your radio.

- 1 Press  to access the menu.

- 2 Press  or  to Call Log. Press  to select.

- 3 Press  or  to the required list. Press  to select.

- 4 Press  or  to the required alias or ID. Press  to select.

- 5 Press  or  to View Details. Press  to select.

The display shows the call details.

7.14

Call Alert Operation

Call Alert paging enables you to alert a specific radio user to call you back.

This feature is applicable for subscriber aliases or IDs only and is accessible through the menu using Contacts or a programmed **One Touch Access** button.

7.14.1

Responding to Call Alerts

When you receive a Call Alert:

- A repetitive tone sounds.
- The yellow LED blinks.

- The display shows the notification list listing a Call Alert with the alias or ID of the calling radio.

Depending on the configuration by your dealer or system administrator, you can respond to a Call Alert by doing one of the following:

- Press the **PTT** button and respond with a Private Call directly to the caller.
 - Press the **PTT** button to continue normal talkgroup communication. The Call Alert is moved to the Missed Call option at the Call Log menu. You can respond to the caller from the Missed Called log.
-

See [Notification List on page 122](#) and [Call Log Features on page 84](#) for more information.

7.14.2

Making Call Alerts

Follow the procedure to make Call Alerts on your radio.



- 1 Press the programmed **One Touch Access** button.

The display shows **Call Alert** and the subscriber alias or ID. The green LED lights up.



- 2 Wait for acknowledgment.

If the Call Alert acknowledgment is received, the display shows a positive mini notice.

If the Call Alert acknowledgment is not received, the display shows a negative mini notice.

- 3 Press  or  to the required alias or ID.

Press  to select.

- 4 Press  or  to **Call Alert**. Press  to select.

The display shows **Call Alert** and the subscriber alias or ID. The green LED lights up.



- 5 Wait for acknowledgment.

- If the acknowledgment is received, the display shows a positive mini notice.
 - If the acknowledgment is not received, the display shows a negative mini notice.
-

7.14.3

Making Call Alerts by Using the Contacts List

- 1 Press  to access the menu.
-

- 2 Press  or  to **Contacts**. Press  to select.
-

7.15

Mute Mode

Mute Mode provides an option to silence all audio indicators on your radio.

When Mute Mode is initiated, all audio indicators are muted except higher priority features such as emergency operations.

When Mute Mode is exited, your radio resumes playing ongoing tones and audio transmissions.



IMPORTANT:

You can only enable either Face Down or Man Down one at a time. Both features cannot be enabled together.

7.15.1

Turning On Mute Mode

Follow the procedure to turn on Mute Mode.

Access this feature by using the programmed **Mute Mode** button.

The following occurs when Mute mode is enabled:

- Positive Indicator Tone sounds.
- Display shows Mute Mode On.
- The red LED light starts blinking and remains blinking until Mute Mode is exited.
- Display shows **Mute Mode** icon on home screen.







- Radio is muted.
- Mute Mode Timer begins counting down the duration that is configured.



7.15.2



Setting Mute Mode Timer

Mute Mode feature can be enabled for a pre-configured amount of time by setting the Mute Mode Timer. The timer duration is configured in the radio menu and can range between 0.5–6 hours. Mute Mode is exited once the timer expires.

If the timer is left at 0, the radio remains in Mute mode for an indefinite period until the programmed **Mute Mode** button is pressed.

- 1 Press  to access the menu.
 - 2 Press  or  to Utilities. Press  to select.
 - 3 Press  or  to Radio Settings. Press  to select.
-

4 Press  or  to Mute Timer. Press  to select.

5 Press  or  to edit the numeric value of each digit, and press .

- If the timer has not expired, Mute mode timer is stopped.



NOTICE:

Mute Mode is also exited if the user transmits voice or switches to an unprogrammed channel.

7.15.3

Exiting Mute Mode

This feature can be exited automatically once the Mute Mode Timer expires.

Do one of the following to exit Mute mode manually:

- Press the programmed **Mute Mode** button.
- Press the **PTT** button on any entry.

The following occurs when Mute mode is disabled:

- Negative Indicator Tone sounds.
- Display shows Mute Mode Off.
- The blinking red LED turns off.
- **Mute Mode** icon disappears from home screen.
- Your radio unmutes and speaker state is restored.

7.16

Emergency Operation

An Emergency Alarm is used to indicate a critical situation. You are able to initiate an Emergency at any time even when there is activity on the current channel.

Your dealer can set the duration of a button press for the programmed **Emergency** button, except for long press, which is similar with all other buttons:

Short Press

Duration between 0.05 seconds and 0.75 seconds.

Long Press

Duration between 1.00 second and 3.75 seconds.

The **Emergency** button is assigned with the Emergency On/Off feature. Check with your dealer for the assigned operation of the **Emergency** button.



NOTICE:

If a short press to the **Emergency** button initiates Emergency mode, then a long press to the same enables the radio to exit Emergency mode.

If a long press to the **Emergency** button initiates Emergency mode, then a short press to the same enables the radio to exit Emergency mode.

Your radio supports three Emergency Alarms:

- Emergency Alarm
- Emergency Alarm with Call
- Emergency Alarm with Voice to Follow



NOTICE:

Only one of the Emergency Alarms above can be assigned to the programmed **Emergency** button.

In addition, each alarm has the following types:

Regular

Radio transmits an alarm signal and shows audio and/or visual indicators.

Silent

Radio transmits an alarm signal without any audio or visual indicators. Radio receives calls without any sound through the speaker, until the programmed *hot mic* transmission period is over and/or you press the **PTT** button.

Silent with Voice

Radio transmits an alarm signal without any audio or visual indicators, but allow incoming calls to sound through the speaker. If *hot mic* is enabled, the incoming calls sound through the speaker after the programmed *hot mic* transmission period is over. The indicators only appear once you press the **PTT** button.

7.16.1

Sending Emergency Alarms

This feature allows you to send an Emergency Alarm, a non-voice signal, which triggers an alert indication on a group of radios. Your radio does not display any audio or visual indicators during Emergency mode when it is set to Silent.

Follow the procedure to send Emergency Alarms on your radio.

1 Press the programmed **Emergency On** button.

You see one of these results:

- The display shows Tx Alarms and the destination alias.
-  The display shows Tx Telegram and the destination alias.

The green LED lights up. The **Emergency** icon appears.



NOTICE:

If programmed, the Emergency Search tone sounds. This tone is muted when the radio transmits or receives voice, and stops when the radio exits Emergency mode. The Emergency Search tone can be programmed through CPS.

2 Wait for acknowledgment.

If successful:

- The Emergency tone sounds.
- The red LED blinks.
- The display shows Alarm Sent.

If unsuccessful after all retries have been exhausted:

- A tone sounds.
- The display shows Alarm Failed.

The radio exits the Emergency Alarm mode and returns to the Home screen.

7.16.2

Sending Emergency Alarms with Call

This feature allows you to send an Emergency Alarm with Call to a group of radios. Upon acknowledgement by a radio within the group, the group of radios can communicate over a programmed Emergency channel. Follow the procedure to send Emergency Alarms with call on your radio.

1 Press the programmed **Emergency On** button.

You see the following:

- The display shows Tx Telegram and the destination alias.

The green LED lights up. The **Emergency** icon appears.



NOTICE:

If programmed, the Emergency Search tone sounds. This tone is muted when the radio transmits or receives voice, and stops when the radio exits Emergency mode. The Emergency Search tone can be programmed by your dealer or system administrator.

2 Wait for acknowledgment.

If successful:

- The Emergency tone sounds.
- The red LED blinks.
- The display shows `Alarm Sent`.
- Your radio enters the Emergency call mode when the display shows `Emergency` and the destination group alias.

3 Press the **PTT** button to make the call.

The green LED lights up. The display shows the **Group Call** icon.

4 Do one of the following:

- Wait for the Talk Permit Tone to end and speak clearly into the microphone if enabled.
-  Wait for the **PTT** Sidetone to end and speak clearly into the microphone if enabled.

5 Release the **PTT** button to listen.

6 If the Channel Free Indication feature is enabled, you hear a short alert tone the moment the transmitting radio releases the **PTT** button, indicating the channel is free for you to respond. Press the **PTT** button to respond to the call.

7 To exit the Emergency mode once the call ends, press the **Emergency Off** button.

If you do not press the **Emergency Off** button to exit the Emergency mode, the red LED blinks and the radio stays in Emergency mode.

The radio returns to the Home screen.

If you press the **PTT** button during *hot mic*, and continue to press it after the *hot mic* duration expires, the radio continues to transmit until you release the **PTT** button.

If the Emergency Alarm request fails, the radio does not retry to send the request, and enters the *hot mic* state directly.



NOTICE:

Some accessories may not support *hot mic*. Check with your dealer or system administrator for more information.

7.16.3

Emergency Alarms with Voice to Follow

This feature allows you to send an Emergency Alarm with Voice to Follow to a group of radios. Your radio microphone is automatically activated, allowing you to communicate with the group of radios without pressing the **PTT** button. This activated microphone state is also known as *hot mic*.

If your radio has Emergency Cycle Mode enabled, repetitions of *hot mic* and receiving period are made for a programmed duration. During Emergency Cycle Mode, received calls sound through the speaker.

If you press the **PTT** button during the programmed receiving period, you hear a prohibit tone, indicating that you should release the **PTT** button. The radio ignores the **PTT** button press and remains in Emergency mode.

7.16.4

Sending Emergency Alarms with Voice to Follow

- 1 Press the programmed **Emergency On** button.

You see one of these results:

- The display shows Tx Alarm and the destination alias.

The green LED lights up. The **Emergency** icon appears.

- 2 Once the Emergency tone sounds, speak clearly into the microphone.

The radio automatically stops transmitting when:

- The cycling duration between *hot mic* and receiving calls expires, if Emergency Cycle Mode is enabled.
- The *hot mic* duration expires, if Emergency Cycle Mode is disabled.

The red LED blinks. The radio remains in Emergency mode.

-
- 3 Press the **Emergency Off** button to exit the Emergency mode.

The radio returns to the Home screen.

7.16.5





Receiving Emergency Alarms

When you receive an Emergency Alarm:

- A tone sounds.
- The red LED blinks.

- The display shows the **Emergency** icon, and the Emergency caller alias or if there is more than one alarm, all emergency caller aliases are displayed in an Alarm List.

- 1 Do one of the following:

- If only one alarm, press  to view more details.
- If more than one alarm, press  or  to the required alias, and press  to view more details.





-
- 2 Press  to view the action options.

-
- 3 Press and select **Yes** to exit the Alarm list.

-
- 4 Press  to access the menu.

-
- 5 Select **Alarm List** to revisit the Alarm list.

-
- 6 To return to home screen, perform the following actions:

- a Press .
- b Press  or  to Yes.
- c Press  to select.

The radio returns to the home screen and the display shows the Emergency icon.

- Press the programmed **Emergency On** button during an emergency initiation or transmission state.

The radio exits the Emergency mode, and reinitiates Emergency.

7.16.7

Exiting Emergency Mode After Sending the Emergency Alarm

This feature is only applicable to the radio sending the Emergency Alarm.

Your radio exits Emergency mode when:

- An acknowledgment is received (for Emergency Alarm only).
- All retries to send the alarm have been exhausted.



NOTICE:

If your radio is powered off, it exits the Emergency mode. The radio does not reinitiate the Emergency mode automatically when it is turned on again.

7.16.6

Reinitiating Emergency Mode

Perform one of the following actions:

- Change the channel while the radio is in Emergency mode.



NOTICE:

You can reinitiate emergency mode only if you enable emergency alarm on the new channel.

Follow the procedure to exit Emergency mode on your radio.

Do one of the following:

- Press the programmed **Emergency Off** button.
- Change the channel to a new channel that has no emergency system configured.

The display shows **No Emergency**.

7.17

Text Messaging

Your radio is able to receive data, for example a text message, from another radio or a text message application.

There are two types of text messages, Digital Mobile Radio (DMR) Short Text Message and text message. The maximum length of a DMR Short Text Message is 23 characters. The maximum length of a text message is 280 characters, including the subject line. The subject line only appears when you receive messages from e-mail applications.



NOTICE:

The maximum character length is only applicable for models with the latest software and hardware. For radio models with older software and hardware, the maximum length of a text message is 140 characters. Contact your dealer for more information.

7.17.1

Sending Quick Text Messages

Follow the procedure to send predefined Quick Text messages on your radio to a predefined alias.



1 Do one of the following:



- Press the programmed **One Touch Access** button.



The display shows a transitional mini notice, confirming your message is being sent.

Proceed to [step 5](#).

- Press  to access the menu.
-

2 Press  or  to **Messages**. Press  to select.

3 Press  or  to Quick Text. Press  to select.

4 Press  or  to the required Quick Text message. Press  to select.

The display shows a transitional mini notice, confirming that your message is being sent.

5 Wait for acknowledgment.

If successful:

- A positive indicator tone sounds.
- The display shows a positive mini notice.

If unsuccessful:

- A negative indicator tone sounds.
- The display shows a negative mini notice.
- The radio proceeds to the Resend option screen. See [Resending Text Messages on page 97](#) for more information.

Resending Text Messages

When you are at the Resend option screen:

Press  to resend the same message to the same subscriber or group alias or ID.

If successful:



- A positive indicator tone sounds.
- The display shows a positive mini notice.

If unsuccessful:

- A negative indicator tone sounds.
- The display shows a negative mini notice.
- The radio returns to the Resend option screen.



NOTICE:

Changing the volume, and pressing any buttons, except for ,  or  returns you to the message.

The radio exits the Resend option screen if you press the **PTT** button to initiate a Private or Group Call, or to respond to a Group Call. The radio also exits the screen when it

receives a text message, an emergency call or alarm, or a call alert.

If you exit the message sending screen while the message is being sent, the radio updates the status of the message in the Sent Items folder without providing any audio or visual indication.

If the radio changes mode or powers down before the status of the message in Sent Items is updated, the radio cannot complete any In-Progress messages and automatically marks it with a **Send Failed** icon.



The radio supports a maximum of five In-Progress messages at one time. During this period, the radio cannot send any new message and automatically marks it with a **Send Failed** icon.



7.17.3

Forwarding Text Messages

Follow the procedure to forward text messages on your radio.

When you are at the **Resend** option screen:

- 1 Press  or  to **Forward**, and press  to send the same message to another subscriber or group alias or ID.
-

- 2 Press  or  to the required alias or ID.
Press  to select.

The display shows a transitional mini notice, confirming your message is being sent.

- 3 Wait for acknowledgment.

If successful:

- A positive indicator tone sounds.
- The display shows a positive mini notice.

If unsuccessful:



- A negative indicator tone sounds.
 - The display shows a negative mini notice.
-



7.17.4

Viewing Sent Text Messages

Follow the procedure to view sent text messages on your radio.

- 1 Do one of the following:
 - Press the programmed **Text Message** button. Proceed to [step 3](#).
 - Press  to access the menu.

- 2 Press  or  to **Messages**. Press  to select.

- 3 Press  or  to **Sent Items**. Press  to select.

If the Sent Items folder is empty:

- The display shows **List Empty**.
- A low tone sounds, if the Keypad Tone is turned on.

- 4 Press  or  to the required message.

Press  to select.

The display shows a subject line if the message is from an e-mail application.

7.17.5

Sending Sent Text Messages

Follow the procedure to send a sent text message on your radio.

When you are viewing a Sent message:

- 1 Press  while viewing the message.

- 2 Press  or  to **Resend**. Press  to select.

The display shows a transitional mini notice, confirming your message is being sent.

- 3 Wait for acknowledgment.

If successful:

- A positive indicator tone sounds.
- The display shows a positive mini notice.

If unsuccessful:



- A negative indicator tone sounds.
- The display shows a negative mini notice.
- The radio proceeds to the **Resend** option screen. See [Resending Text Messages on page 97](#) for more information.



7.17.6

Deleting All Sent Text Messages from the Sent Items Folder

Follow the procedure to delete all sent text messages from the Sent Items folder on your radio.



- 1 Do one of the following:
 - Press the programmed **Text Message** button. Proceed to [step 3](#).
 - Press  to access the menu.







- 2 Press  or  to **Messages**. Press  to select.

- 3 Press  or  to **Sent Items**. Press  to select.

If the Sent Items folder is empty:

- The display shows **List Empty**.
- A tone sounds.

- 4 Press  or  to **Delete All**. Press  to select.

- 5 Do one of the following:
 - Press  or  to **Yes**. Press  to select. The display shows a positive mini notice.
 - Press  or  to **No**. Press  to select. The radio returns to the previous screen.

7.17.7

Responding to Text Messages

Follow the procedure to respond to text messages on your radio.

When you receive a text message:







- The display shows the Notification list with the alias or ID of the sender.
- The display shows the **Message** icon.



NOTICE:

The radio exits the Text Message alert screen and sets up a Private or Group Call to the sender of the message if the **PTT** button is pressed.

1 Do one of the following:

- Press  or  to Read. Press  to select.
The display shows the text message. The display shows a subject line if the message is from an e-mail application.
- Press  or  to Read Later. Press  to select.

The radio returns to the screen you were on prior to receiving the text message.

- Press  or  to Delete. Press  to select.

2

Press  to return to the Inbox.



7.17.8

Viewing Text Messages



1

Press  to access the menu.

2

Press  or  to Messages. Press  to select.

3

Press  or  to Inbox. Press  to select.

If the Inbox is empty:

- The display shows List Empty.
- A tone sounds, if the Keypad Tone is turned on.

4 Press  or  to the required message.

Press  to select.

The display shows a subject line if the message is from an e-mail application.



7.17.9

Deleting Text Messages from the Inbox

Follow the procedure to delete text messages from the Inbox on your radio.

1 Do one of the following:

- Press the programmed **Text Message** button. Proceed to [step 3](#).
 - Press  to access the menu.
-

2 Press  or  to **Messages**. Press  to select.

3 Press  or  to **Inbox**. Press  to select.

If the Inbox is empty:

- The display shows **List Empty**.
 - A tone sounds.
-



4 Press  or  to the required message.

Press  to select.

The display shows a subject line if the message is from an e-mail application.

5 Press  to access the sub-menu.

6 Press  or  to **Delete**. Press  to select.

7 Press  or  to **Yes**. Press  to select.



The display shows a positive mini notice. The screen returns to the Inbox.



7.17.10

Deleting All Text Messages from the Inbox

Follow the procedure to delete all text messages from the Inbox on your radio.



- 1 Do one of the following:
 - Press the programmed **Text Message** button. Proceed to [step 3](#).
 - Press  to access the menu.



- 2 Press  or  to `Messages`. Press  to select.

- 3 Press  or  to `Inbox`. Press  to select.

If the Inbox is empty:

 - The display shows `List Empty`.
 - A tone sounds.

- 4 Press  or  to `Delete All`. Press  to select.

- 5 Press  or  to `Yes`. Press  to select.

The display shows a positive mini notice.

7.18

Analog Status Update

Your radio is able to send preprogrammed messages from the Status list indicating your current activity to a radio contact (for 5-Tone systems) or the dispatcher (for Motorola Data Communication systems).



The last acknowledged message is kept at the top of the Status list. The other messages are arranged in alphanumeric order.

7.18.1



Sending Status Updates to Predefined Contacts

Follow the procedure to send status updates to predefined contacts on your radio.

1 Press  or  to Status. Press  to select.

2 Press  or  to the required status. Press  to select.

When you press the **PTT** button while in the Status list for 5-Tone systems, the radio sends the selected status update, and returns to the Home screen to initiate a voice call.

3 Press  or  to Set as Default. Press  to select.

The display shows a transitional mini notice, confirming the status update is being sent.

4 Wait for acknowledgment.

If successful:

- A positive indicator tone sounds.
- The display shows a positive mini notice.
- The display shows ✓ beside the acknowledged status.

If unsuccessful:

- A negative indicator tone sounds.
 - The display shows a negative mini notice.
 - The display shows ✓ beside the previous status.
-

See [Setting Default Contact on page 78](#) for more information on setting the default contact for 5-Tone systems.



7.18.2



Viewing 5-Tone Status Details

Follow the procedure to view 5-tone status details on your radio.

It is assumed that you have purchased the Software License Key.

1 Press  or  to Status. Press  to select.

2 Press  or  to the required status. Press  to select.

- 3 Press  or  to View Details. Press  to select.

The display shows details of the selected status.

7.19





Analog Message Encode



Your radio can send preprogrammed messages from the Message list to a radio alias or the dispatcher.



7.19.1

Sending MDC Encode Messages to Dispatchers

Follow the procedure to send MDC Encode messages to dispatchers on your radio.

- 1 Press  to access the menu.
-
- 2 Press  or  to Message. Press  to select.
-

- 3 Press  or  to Quick Text. Press  to select.
-

- 4 Press  or  to the required message. Press  to select.

The display shows a transitional mini notice, confirming the message is being sent.

- 5 Wait for acknowledgment.

If successful:

- A positive indicator tone sounds.
- The display shows a positive mini notice.

If unsuccessful:



- A negative indicator tone sounds.
 - The display shows a negative mini notice.
-



7.19.2



Sending 5-Tone Encode Messages to Contacts



Follow the procedure to send 5-Tone Encode messages to contacts on your radio.

- 1 Press  to access the menu.

- 2 Press  or  to Message. Press  to select.

- 3 Press  or  to Quick Text. Press  to select.

- 4 Press  or  to the required message. Press  to select.

- 5 Press  or  to the required contact. Press  to select.
The display shows a transitional mini notice, confirming the message is being sent.

- 6 Wait for acknowledgment.

If successful:

- A positive indicator tone sounds.
- The display shows a positive mini notice.

If unsuccessful:

- A negative indicator tone sounds.
- The display shows a negative mini notice.



NOTICE:

Check with your dealer or system administrator for more information.



7.20

Setting a Default 5-Tone Contact

Follow the procedure to set a default 5-Tone contact:

- 1 Press  to access the menu.

- 2 Press  to select Contacts.

3 Press  or  to the desired contact. Press  to select.

4 Press  to select Set as Default.

5 The following occurs:

- A positive indicator tone sounds.
 - The display shows a positive mini notice.
 - The display shows ✓ beside the selected contact.
-

- Press the **PTT** button to call the default contact. Skip the following steps.

- Press  to access the menu.
-

3 Press  to select Contacts.

4 Press  or  to the desired contact.

5 Press the **PTT** button to make the call.

6 Wait for acknowledgment.

If successful:

- A positive indicator tone sounds.
- The display shows the **Monitor** icon momentarily.
- Wait for the Talk Permit Tone to end and speak clearly into the microphone if enabled.

If unsuccessful:

- A negative indicator tone sounds.
-

The call ends when there is no voice activity for a predetermined period. A tone sounds. The display shows Call Ended.

7.20.1

Making 5-Tone Calls

Follow the procedure to make a 5-Tone Call:

1 Select the 5-Tone channel with the required contact or status list.

2 Do one of the following:

7.20.2

Receiving 5-Tone Calls

When you receive a 5-Tone Call:

- The green LED blinks.
- A tone sounds.
- The display shows the **Private Call** icon and the caller alias.
- Your radio unmutes and the incoming call sounds through the speaker.

- 1 Press the **PTT** button to respond to the call.
The green LED lights up.
-

- 2 Wait for the Talk Permit Tone to end and speak clearly into the microphone if enabled.
-

- 3 Release the **PTT** button to listen.

The call ends when there is no voice activity for a predetermined period. A tone sounds. The display shows the **Monitor** icon momentarily.

Sending 5-Tone Emergency Alarm

Follow the procedure to send an Emergency Alarm:

- 1 Press the programmed **Emergency On** button.

You see the following:

- The display shows Tx Alarm and the channel alias momentarily.
 - The green LED lights up.
 - The **Emergency** icon appears.
 - The Emergency tone sounds.
 - The display shows Alarm Sent.
-

- 2 The radio exits the Emergency Alarm mode and returns to the Home screen.
-

7.20.4

Sending 5-Tone Emergency Alarm with Voice to Follow

7.20.3

Follow the procedure to send an Emergency Alarm on your radio.

1 Press the programmed **Emergency On** button.

You see the following:

- The green LED lights up.
- The display shows `Tx Alarm` and the channel alias momentarily.
- The **Emergency** icon appears.
- The Emergency tone sounds.
- The display shows `Alarm Sent`.
- Your radio enters the Emergency call mode when the display shows `Emergency`.

2 Once the display shows `Alarm Sent`, speak clearly into the microphone.

The radio automatically stops transmitting when the cycling duration between *hot mic* and receiving calls expires, if Emergency Cycle Mode is enabled.

The red LED blinks. The radio remains in Emergency mode.

3 Release the **PTT** button to listen.

4 To exit the Emergency mode once the call ends, press the **Emergency Off** button.

If you do not press the **Emergency Off** button to exit the Emergency mode, the red LED blinks and the radio stays in Emergency mode.

The radio returns to the Home screen.





7.20.5

Receiving 5-Tone Emergency Alarm

When you receive an Emergency Alarm:

- A tone sounds.
- The red LED blinks.
- The display shows the **Emergency** icon, and the Emergency caller alias or if there is more than one alarm, all emergency caller aliases are displayed in an Alarm List.

1 Do one of the following:

- If only one alarm, press  to view more details.
- If more than one alarm, press  or  to the required alias, and press  to view more details.

2 Press  to view the action options.

3 Press  and select Yes to exit the Notification list.

7.21

Privacy

This feature helps to prevent eavesdropping by unauthorized users on a channel by the use of a software-based scrambling solution. The signaling and user identification portions of a transmission are not scrambled.

Your radio must have privacy enabled on the channel to send a privacy-enabled transmission, although this is not a necessary requirement for receiving a transmission. While on a privacy-enabled channel, the radio is still able to receive clear or unscrambled transmissions.

Some radio models may not offer Privacy feature, or may have a different configuration. Check with your dealer or system administrator for more information.

Your radio supports two types of privacy, but only one can be assigned to your radio. They are:

- Basic Privacy
- Enhanced Privacy

To unscramble a privacy-enabled call or data transmission, your radio must be programmed to have the same Privacy Key for Basic Privacy, or the same Key Value and Key ID for Enhanced Privacy as the transmitting radio.

If your radio receives a scrambled call that is of a different Privacy Key, or different Key Value and Key ID, you either hear a garbled transmission for Basic Privacy or nothing at all for Enhanced Privacy.

On a privacy-enabled channel, your radio is able to receive clear or unscrambled calls, depending on how your radio is programmed. In addition, your radio may play a warning tone or not, depending on how it is programmed.

If the radio has a privacy type assigned, the Home Screen shows the **Secure** or **Unsecure** icon, except when the radio is sending or receiving an Emergency call or alarm.

The green LED lights up when the radio is transmitting, and blinks rapidly when the radio is receiving an ongoing privacy-enabled transmission.



NOTICE:



This feature is not applicable in Citizens Band channels that are in the same frequency.



7.21.1



Turning Privacy On or Off

Follow the procedure to turn privacy on or off on your radio.

- 1 Do one of the following:
 - Press the programmed **Privacy** button. Skip the proceeding steps.
 - Press  to access the menu.

- 2 Press  or  to Utilities. Press  to select.

- 3 Press  or  to Radio Settings. Press  to select.

- 4 Press  or  to *<required privacy>*.

Press  to select.

- If privacy is on, display shows ✓ beside Enabled.
- If privacy is off, display shows empty box beside Enabled.

7.22

Response Inhibit

This feature helps prevent your radio from responding to any incoming transmissions.



NOTICE:

Contact your dealer to determine how your radio has been programmed.

If enabled, your radio does not generate any outgoing transmissions in respond to incoming transmissions, such as Radio Check, Call Alert, Radio Disable, Remote Monitor, Automatic Registration Service (ARS), Responding to Private Messages, and Sending GNSS location reports.

Your radio cannot receive Confirmed Private Calls when this feature is enabled. However, your radio is able to manually send transmission.

7.22.1

Turning Response Inhibit On or Off

Follow the procedure to enable or disable Response Inhibit on your radio.

Press the programmed **Response Inhibit** button.

If successful:

- A positive indicator tone sounds.
- The display shows a momentary positive mini notice.

If unsuccessful:

- A negative indicator tone sounds.
- The display shows a momentary negative mini notice.

7.23

Covert Mode

Your radio is capable of Covert Mode. During covert mode, all keypad and programmed button access are blocked. When enabled, all visual indications (display, LEDs and backlight) are disabled.

This feature allows audio or tone only by using a wired accessory or a Bluetooth accessory.

7.23.1

Entering Covert Mode

Press **Volume Up** and **Volume Down** button alternately 6 times (+ - + - + -), all in five seconds.

Radio enters into Covert Mode.

7.23.2

Exiting Covert Mode

Press **Volume Up** and **Volume Down** button alternately 6 times (+ - + - + -), all in five seconds.

Radio returns to normal mode.

7.24

Security

This feature allows you to enable or disable any radio in the system.

For example, you may want to disable a stolen radio to prevent unauthorized users from using it, and enable the radio when it is recovered.

There are two ways to enable or disable a radio, with authentication and without authentication.

Authenticated Radio Disable is a purchasable feature. In Authenticated Radio Disable, verification is required when you enable or disable a radio. When your radio initiates this feature on a target radio with User Authentication, a passphrase is required. The passphrase is preprogrammed in the target radio through CPS.

You will not receive an acknowledgment if you press  during Radio Enable or Radio Disable operation.



NOTICE:

Check with your dealer or system administrator for more information.

7.24.1

Disabling Radios

Follow the procedure to disable your radio.

- 1 Press the programmed **Radio Disable** button.

- 2 Press  or  to the required alias or ID.

- 3 Press  to select. One of the following scenarios occurs:

- The display shows a transitional mini notice, indicating the request is in progress. The green LED blinks.
- A passphrase screen appears.

Enter the passphrase. Press  to proceed.

- If the passphrase is correct, the display shows a transitional mini notice, indicating the request is in progress. The green LED lights up.
- If the passphrase is incorrect, the display shows a negative mini notice, and returns to the previous screen.

- 4 Wait for acknowledgment.

If successful:

- A positive indicator tone sounds.
- The display shows a positive mini notice.

If unsuccessful:

- A negative indicator tone sounds.



- The display shows a negative mini notice.
-



7.24.2



Disabling Radios by Using the Contacts List

Follow the procedure to disable your radio by using the Contacts list.

- 1 Press  to access the menu.

- 2 Press  or  to `Contacts`. Press  to select.

- 3 Press  or  to the required alias or ID.
Press  to select.

- 4 Press  or  to `Radio Disable`.

- 5 Press  to select. One of the following scenarios occurs:

- The display shows a transitional mini notice, indicating the request is in progress. The green LED blinks.
- A passphrase screen appears.

Enter the passphrase. Press  to proceed.

- If the passphrase is correct, the display shows a transitional mini notice, indicating the request is in progress. The green LED lights up.
 - If the passphrase is incorrect, the display shows a negative mini notice, and returns to the previous screen.
-

6 Wait for acknowledgment.

If successful:

- A positive indicator tone sounds.
- The display shows a positive mini notice.

If unsuccessful:



- A negative indicator tone sounds.
 - The display shows a negative mini notice.
-



7.24.3

Disabling Radios by Using the Manual Dial



Follow the procedure to disable your radio by using the manual dial.

- 1 Press  to access the menu.

- 2 Press  or  to `Contacts`. Press  to select.

- 3 Press  or  to `Manual Dial`. Press  to select.

- 4 Enter the subscriber ID, and press  to proceed.

- 5 Press  or  to `Radio Disable`.

- 6 Press  to select. One of the following scenarios occurs:

- The display shows a transitional mini notice, indicating the request is in progress. The green LED blinks.
- A passphrase screen appears.

Enter the passphrase. Press  to proceed.

- If the passphrase is correct, the display shows a transitional mini notice, indicating the request is in progress. The green LED lights up.
- If the passphrase is incorrect, the display shows a negative mini notice, and returns to the previous screen.

7 Wait for acknowledgment.

If successful:

- A positive indicator tone sounds.
- The display shows a positive mini notice.

If unsuccessful:



- A negative indicator tone sounds.
- The display shows a negative mini notice.

7.24.4

Enabling Radios

Follow the procedure to enable your radio.

- 1 Press the programmed **Radio Enable** button.

- 2 Press  or  to the required alias or ID.

- 3 Press  to select. One of the following scenarios occurs:
 - The display shows **Radio Enable** and the subscriber alias or ID. The green LED lights up.
 - A passphrase screen appears.

Enter the passphrase. Press  to proceed.

- If the passphrase is correct, the display shows a transitional mini notice, indicating the request is in progress. The green LED lights up.
 - If the passphrase is incorrect, the display shows a negative mini notice, and returns to the previous screen.
-

- 4 Wait for acknowledgment.

If successful:

- A positive indicator tone sounds.
- The display shows a positive mini notice.

If unsuccessful:



- A negative indicator tone sounds.
 - The display shows a negative mini notice.
-



7.24.5

Enabling Radios by Using the Contacts List

Follow the procedure to enable your radio by using the Contacts list.

- 1 Press  to access the menu.

- 2 Press  or  to **Contacts**. Press  to select.

- 3 Press  or  to the required alias or ID.
Press  to select.
-

- 4 Press  or  to Radio Enable.
-

- 5 Press  to select. One of the following scenarios occurs:

- The green LED blinks. The display shows Radio Enable and the subscriber alias or ID. The green LED lights up.
- A passphrase screen appears.

Enter the passphrase. Press  to proceed.

- If the passphrase is correct, the display shows a transitional mini notice, indicating the request is in progress. The green LED lights up.
 - If the passphrase is incorrect, the display shows a negative mini notice, and returns to the previous screen.
-

- 6 Wait for acknowledgment.

If successful:

- A positive indicator tone sounds.
- The display shows a positive mini notice.







If unsuccessful:



- A negative indicator tone sounds.
 - The display shows a negative mini notice.
-

7.24.6

Enabling Radios by Using the Manual Dial

Follow the procedure to enable your radio by using the manual dial.

- 1 Press  to access the menu.
-
- 2 Press  or  to Contacts. Press  to select.
-
- 3 Press  or  to Manual Dial. Press  to select.
-

- 4 Press  or  to Private Call. Press  to select.

The first text line shows Radio Number:.

- 5 Enter the subscriber ID, and press  to proceed.
-

- 6 Press  or  to Radio Enable.
-

- 7 Press  to select. One of the following scenarios occurs:

- The green LED blinks. The display shows Radio Enable and the subscriber alias or ID. The green LED lights up.
- A passphrase screen appears.

Enter the passphrase. Press  to proceed.

- If the passphrase is correct, the display shows a transitional mini notice, indicating the request is in progress. The green LED lights up.

- If the passphrase is incorrect, the display shows a negative mini notice, and returns to the previous screen.
-

- 8 Wait for acknowledgment.

If successful:

- A positive indicator tone sounds.
- The display shows a positive mini notice.

If unsuccessful:

- A negative indicator tone sounds.
 - The display shows a negative mini notice.
-

7.25

Lone Worker

This feature prompts an emergency to be raised if there is no user activity, such as any radio button press or channel selection, for a predefined time.

Following no user activity for a programmed duration, the radio pre-warns you using an audio indicator once the inactivity timer expires.

If there is still no acknowledgment by you before the predefined reminder timer expires, the radio initiates an Emergency Alarm.

Only one of the following Emergency Alarms is assigned to this feature:

- Emergency Alarm
- Emergency Alarm with Call
- Emergency Alarm with Voice to Follow 

The radio remains in the emergency state, allowing voice messages to proceed until action is taken. See [Emergency Operation on page 89](#) for more information on ways to exit Emergency.



NOTICE:

Check with your dealer or system administrator for more information.

7.26

Password Lock

You can set a password to restrict access to your radio. Each time you turn on your radio, you are asked to enter the password.





Your radio supports a 4-digit password input.

Your radio is unable to receive calls in locked state.

7.26.1

Accessing the Radio by Using Password

Turn on your radio.

- 1 Enter the four-digit password.
 - a To edit the numeric value of each digit, press  or . To enter and move to the next digit, press .
-
- 2 Press  to confirm the password.
-

If you enter the password correctly, the radio powers up.

If you enter the wrong password after the first and second attempt, your radio shows the following indications:

- A continuous tone sounds.
- The display shows `Wrong Password`.

Repeat [step 1](#).

If you enter the wrong password after the third attempt, your radio shows the following indications:

- A tone sounds.
- The yellow LED double blinks.
- The display shows `Wrong Password` and then, `Radio Locked`.
- Your radio enters into locked state for 15 minutes.



NOTICE:

In locked state, your radio responds to inputs from the **On/Off** and programmed **Backlight** button only.

Wait for the 15-minute locked state timer to end and then repeat [step 1](#).



NOTICE:

If you turn off and turn your radio on again, the 15-minute timer restarts.

7.26.2

Unlocking Radios in Locked State

Your radio is unable to receive calls in locked state. Follow the procedure to unlock your radio in locked state.

Do one of the following:

- If the radio is powered on, wait for 15 minutes and then repeat the steps in [Accessing the Radio by Using Password on page 119](#) to access the radio.
- If the radio is powered off, power up the radio. Your radio restarts the 15-minute timer for locked state. A tone sounds. The yellow LED double blinks. The display shows `Radio Locked`.



Wait for 15 minutes and then repeat the steps in [Accessing the Radio by Using Password on page 119](#) to access the radio.

7.26.3



Turning Password Lock On or Off

Follow the procedure to turn password lock on or off on your radio.



- 1 Press  to access the menu.

- 2 Press  or  to `Utilities`. Press  to select.

3 Press  or  to Radio Settings. Press  to select.

4 Press  or  to Passwd Lock. Press  to select.



5 Enter the current four-digit password.

- Use a keypad microphone.
 - Press  or  to edit the numeric value of each digit, and press  to enter and move to the next digit.
A positive indicator tone sounds for every digit pressed.
-

6 Press  to enter the password.

If the password is incorrect, the display shows Wrong Password and automatically returns to the previous menu.

7 Do one of the following:

- Press  or  to Turn On. Press  to select.

The display shows ✓ beside Turn On.

- Press  or  to Turn Off. Press  to select.



The display shows ✓ beside Turn Off.

7.26.4



Changing Passwords

Follow the procedure to change passwords on your radio.

1 Press  to access the menu.

2 Press  or  to Utilities. Press  to select.



3 Press  or  to Radio Settings. Press  to select.

4 Press  or  to Passwd Lock. Press  to select.

- 5 Enter the current four-digit password, and press

 to proceed.

If the password is incorrect, the display shows Wrong Password and automatically returns to the previous menu.

- 6 Press  or  to Change PWD. Press  to select.

- 7 Enter a new four-digit password, and press  to proceed.

- 8 Re-enter the new four-digit password, and press

 to proceed.

If successful, the display shows Password Changed. If unsuccessful, the display shows Passwords Do Not Match.

The screen automatically returns to the previous menu.

Notification List

Your radio has a Notification list that collects all your unread events on the channel, such as unread text messages, telemetry messages, missed calls, and call alerts.

The display shows the **Notification** icon when the Notification list has one or more events.

The list supports a maximum of 40 unread events. When the list is full, the next event automatically replaces the oldest event. After the events are read, they are removed from the Notification list.

For text messages, missed calls, and call alert events, the maximum number of notifications are 30 text messages and 10 missed calls or call alerts. This maximum number depends on individual feature (job tickets or text messages or missed calls or call alerts) list capability.



NOTICE:

Your radio suspends Scan when the Notification list is displayed. Scanning resumes when your radio exits the Notification list. Press , or wait for the menu timer to expire to exit the Notification list.



7.27.1



Accessing Notification List

Follow the procedure to access the Notification list on your radio.

- 1 Do one of the following:
 - Press the programmed **Notification** button. Skip the steps below.
 - Press  to access the menu.

- 2 Press  to access the menu.

- 3 Press  or  to Notification. Press  to select.

- 4 Press  or  to the required event. Press  to select.

Long press  to return to the Home screen.

Auto-Range Transponder System



The Auto-Range Transponder System (ARTS) is an analog-only feature designed to inform you when your radio is out-of-range of other ARTS-equipped radios.

ARTS-equipped radios transmit or receive signals periodically to confirm that they are within range of each other.

Your radio provides indications of states as follows:

First-Time Alert

A tone sounds.

The display shows channel alias and In Range.

ARTS-in-Range Alert

A tone sounds, if programmed.

The display shows channel alias and In Range.

ARTS-Out-of-Range Alert

A tone sounds. The red LED rapidly blinks.

The display shows `Out of Range` alternating with the Home screen.



NOTICE:

Check with your dealer or system administrator for more information.

7.29

Over-the-Air Programming

Your dealer can remotely update your radio through Over-the-Air Programming (OTAP) without any physical connection. Additionally, some settings can also be configured by using OTAP.

When your radio undergoes OTAP, the green LED blinks.

When your radio receives high volume data:

- The display shows the **High Volume Data** icon.
- The channel becomes busy.
- A negative tone sounds if you press the **PTT** button.

When OTAP completes, depending on the configuration:

- A tone sounds. The display shows `Updating Restarting`. Your radio restarts by powering off and on again.

- You can select `Restart Now` or `Postpone`. When you select `Postpone`, your radio returns to the previous screen. The display shows the **OTAP Delay Timer** icon until the automatic restart occurs.

When your radio powers up after automatic restart:

- If successful, the display shows `Sw Update Completed`.
- If the program update is unsuccessful, a tone sounds, the red LED blinks once, and the display shows `Sw Update Failed`.



NOTICE:

If the programming update is unsuccessful, the software update failure indications appear every time you turn on your radio. Contact your dealer to reprogram your radio with the latest software to eliminate the software update failure indications.

See [Checking Software Update Information on page 146](#) for the updated software version.

7.30

Wi-Fi Operation

This feature allows you to set up and connect to a Wi-Fi network. Wi-Fi supports updates for radio firmware,

codeplug, and resources such as language packs and voice announcement.

Wi-Fi® is a registered trademark of Wi-Fi Alliance®.

Your radio supports WEP/WPA/WPA2-Personal and WPA/WPA2-Enterprise Wi-Fi networks.

WEP/WPA/WPA2-Personal Wi-Fi network

Uses pre-shared key (password) based authentication.

Pre-shared key can be entered by using the menu or CPS/RM.

WPA/WPA2-Enterprise Wi-Fi network

Uses certificate-based authentication.

Your radio must be pre-configured with a certificate.



NOTICE:

Check with your dealer or system administrator to connect to WPA/WPA2-Enterprise Wi-Fi network.

The programmed **Wi-Fi On or Off** button is assigned by your dealer or system administrator. Check with your dealer or system administrator to determine how your radio has been programmed.

Voice Announcements for the programmed **Wi-Fi On or Off** button can be customized through CPS according to

user requirements. Check with your dealer or system administrator for more information.







NOTICE:

You can turn on or turn off Wi-Fi remotely by using a designated radio (see [Turning Wi-Fi On or Off Remotely by Using a Designated Radio \(Individual Control\)](#) on page 126 and [Turning Wi-Fi On or Off Remotely by Using a Designated Radio \(Group Control\)](#) on page 127). Check with your dealer or system administrator for more information.

7.30.1

Turning Wi-Fi On or Off

- 1 Press the programmed **Wi-Fi On or Off** button. Voice Announcement sounds Turning On Wi-Fi or Turning Off Wi-Fi.

- 2 Access this feature using the menu.
 - a Press  to access the menu.
 - b Press  or  to Wi-Fi and press  to select.

- c Press  or  to Turn On and press  to select.

The radio displays Turning On WiFi.

If Wi-Fi is enabled and a low capacity battery is used, an alert screen is displayed upon power-up with the following notice.

- Low Capacity Battery!
- Tx power restricted to 2 W and Wi-Fi disabled.
- Use a compatible battery to lift restriction.
- Press  to continue.

Lift the restriction to enable 3 W operation and Wi-Fi by performing the following action.

Power off the radio and change to a compatible battery such as Lithium-Ion 2300 mAh Battery Pack (PMNN4468_).

If Wi-Fi is disabled and a low capacity battery is used, the transmit power is restricted to 2 W.

7.30.2

Turning Wi-Fi On or Off Remotely by Using a Designated Radio (Individual Control)



You can turn Wi-Fi on or off remotely in Individual Control (One to One).



NOTICE:

Only radio with specific CPS setting supports this function, check with your dealer or system administrator for more information.

1 Do one of the following:

- Long press the programmable button. Use the keypad to enter the ID and press  to select. Proceed to [step 3](#).
- Press  to access the menu.

2 Press or to Contacts and press to select.

3 Press or to WiFi Control and press to select.

4 Press P1 or P2 to select On or Off.

5 Press to select.

If successful, the display shows a positive mini notice.

If unsuccessful, the display shows a negative mini notice.

7.30.3

Turning Wi-Fi On or Off Remotely by Using a Designated Radio (Group Control)

You can turn Wi-Fi on or off remotely in Group Control (One to Many).



NOTICE:

Only radio with specific CPS setting supports this function, check with your dealer or system administrator for more information.

1 Press to access the menu.

2 Press P1 or P2 to `Contacts` and press to select.

3 Press P1 or P2 to select the required subscriber alias or ID.

4 Press P1 or P2 to `WiFi Control` and press to select.

5 Press P1 or P2 to select On or Off.

6 Press to select.

If successful, the display shows `Sent Successfully`.

If unsuccessful, the display shows a negative mini notice.

7.30.4

Connecting to a Network Access Point



When you turn on Wi-Fi, the radio scans and connects to a network access point.













NOTICE:

The WPA-Enterprise Wi-Fi network access points are pre-configured. Check with your dealer or system administrator to determine how your radio has been programmed.

- 1 Press  to access the menu.

 - 2 Press  or  to WiFi and press  to select.

 - 3 Press  or  to Networks and press  to select.

 - 4 Press  or  to a network access point and press  to select.
-  **NOTICE:**
For WPA-Enterprise Wi-Fi, if a network access point is not preconfigured, the Connect option is not available.
-
- 5 Press  or  to Connect and press  to select.

 - 6 For WPA-Enterprise Wi-Fi, password is configured by using RM.
If the preconfigured password is correct, your radio automatically connects to the selected network access point.

If the preconfigured password is incorrect, the display shows Authentication Failure, and automatically returns to the previous menu.

If the connection is successful, the radio displays a notice and the network access point is saved into the profile list.

If the connection is unsuccessful, the radio displays shows the failure notice screen momentarily and automatically returns to the previous menu.

7.30.5

Checking Wi-Fi Connection Status

Press the programmed **Wi-Fi Status Query** button for the connection status by using Voice Announcement. Voice Announcement sounds Wi-Fi is Off, Wi-Fi is On but No Connection, or Wi-Fi is On with Connection.

- The display shows WiFi Off when the Wi-Fi is turned off.
- The display shows WiFi On, Connected when the radio is connected to a network.
- The display shows WiFi On, Disconnected when the Wi-Fi is turned on but the radio is not connected to any network.

Voice Announcements for the Wi-Fi status query results can be customized through CPS according to user requirements. Check with your dealer or system administrator for more information.



NOTICE:



The programmed **Wi-Fi Status Query** button is assigned by your dealer or system administrator. Check with your dealer or system administrator to determine how your radio has been programmed.



7.30.6



Viewing Details of Network Access Points

You can view details of network access points.

- 1 Press  to access the menu.

- 2 Press  or  to **WiFi** and press  to select.

- 3 Press  or  to a network access point and press  to select.

- 4 Press  or  to **View Details** and press  to select.



NOTICE:

WPA-Personal Wi-Fi and WPA-Enterprise Wi-Fi display different details of Network Access Points.

WPA-Personal Wi-Fi

For a connected network access point, your radio displays Service Set Identifier (SSID), Security Mode, Media Access Control (MAC) address, and Internet Protocol (IP) address.

WPA-Enterprise Wi-Fi

For a connected network access point, your radio displays SSID, Security Mode, Identity, Extended Authentication Protocol (EAP) Method, Phase 2 Authentication, Cert Name, MAC address, IP address, Gateway, DNS1, and DNS2.

Utilities

This chapter explains the operations of the utility functions available in your radio.

8.1

Squelch Levels

You can adjust the squelch level to filter out unwanted calls with low signal strength or channels with noise higher than normal background.

Normal

This is the default setting.

Tight

This setting filters out unwanted calls and/or background noise. Calls from remote locations may also be filtered out.



NOTICE:



This feature is not applicable in Citizens Band channels that are in the same frequency.



8.1.1



Setting Squelch Levels



Follow the procedure to set the squelch levels on your radio.

- 1 Do one of the following:
 - Press the programmed **Squelch** button. Skip the following steps.
 - Press  to access the menu.

- 2 Press  or  to Utilities. Press  to select.

- 3 Press  or  to Radio Settings. Press  to select.

- 4 Press  or  to Squelch. Press  to select.

- 5 Do one of the following:
 - Press  or  to Normal. Press  to select.
The display shows ✓ beside Normal.

- Press  or  to Tight. Press  to select.

The display shows ✓ beside Tight.

The screen automatically returns to the previous menu.

8.2

Power Levels

You can customize the power setting to high or low for each channel.

High

This enables communication with radios located at a considerable distance from you.

Low

This enables communication with radios in closer proximity.



NOTICE:



This feature is not applicable in Citizens Band channels that are in the same frequency.

8.2.1

Setting Power Levels



Follow the procedure to set the power levels on your radio.

- 1 Do one of the following:
 - Press the programmed **Power Level** button. Skip the steps below.
 - Press  to access the menu.

- 2 Press  or  to Utilities. Press  to select.

- 3 Press  or  to Radio Settings. Press  to select.

- 4 Press  or  to Power. Press  to select.

- 5 Do one of the following:
 - Press  or  to High. Press  to select.
The display shows ✓ beside High.

- Press  or  to Low. Press  to select.

The display shows ✓ beside Low.



- 6 Long press  to return to the Home screen.
-



8.3



Adjusting Display Brightness

Follow the procedure to adjust the display brightness on your radio.

- 1 Do one of the following:
 - Press the programmed **Brightness** button. Skip the following steps.
 - Press  to access the menu.
-

- 2 Press  or  to Utilities. Press  to select.
-

- 3 Press  or  to Radio Settings. Press  to select.
-

- 4 Press  or  to Brightness. Press  to select.

The display shows the progress bar.

- 5 Press  or  to decrease or increase the display brightness. Press  to select.

The setting value is varied from 1 to 8.

8.4

Voice Operating Transmission

The Voice Operating Transmission (VOX) allows you to initiate a hands-free voice-activated call on a programmed channel. The radio automatically transmits, for a programmed period, whenever the microphone on the VOX-capable accessory detects voice.



NOTICE:

This feature is not applicable in Citizens Band channels that are in the same frequency.

You can enable or disable VOX by doing one of the following:

- Turn the radio off and then power it on again to enable VOX.
- Change the channel by using the **Channel Rocker**.
- Turn VOX on or off by using the programmed **VOX** button or menu to enable or disable VOX.
- Press the **PTT** button during radio operation to disable VOX.

**NOTICE:**



Turning this feature on or off is limited to radios with this function enabled. Check with your dealer or system administrator for more information.

8.4.1

Turning Voice Operating Transmission On or Off

Follow the procedure to turn VOX on or off on your radio.







- 1 Do one of the following:
 - Press the programmed **VOX** button. Skip the steps below.
 - Press  to access the menu.

- 2 Press  or  to Utilities. Press  to select.

- 3 Press  or  to Radio Settings. Press  to select.

- 4 Press  or  to VOX. Press  to select.

- 5 Do one of the following:

- Press  or  to On. Press  to select. The display shows ✓ beside On.
- Press  or  to Off. Press  to select. The display shows ✓ beside Off.

**NOTICE:**



If the Talk Permit Tone is enabled, use a trigger word to initiate the call. Wait for the Talk Permit Tone to finish before speaking clearly into the microphone. See [Turning Talk Permit Tone On or Off on page 136](#) for more information.



8.5



Setting Display Backlight Timer



You can set the display backlight timer of the radio as needed. The setting also affects the Menu Navigation Buttons and keypad backlighting accordingly. Follow the procedure to set the backlight timer on your radio.

- 1 Do one of the following:
 - Press the programmed **Backlight** button. Skip the following steps.
 - Press  to access the menu.

- 2 Press  or  to Utilities. Press  to select.

- 3 Press  or  to Radio Settings. Press  to select.

- 4 Press  or  to Display. Press  to select.

- 5 Press  or  to Backlight Timer. Press  to select.
-

The display backlight and keypad backlighting are automatically turned off as the LED indicator is disabled. See [Turning LED Indicators On or Off on page 137](#) for more information.

8.6

Turning Radio Tones/Alerts On or Off

You can enable and disable all radio tones and alerts, if needed, except for incoming Emergency alert tone . Follow the procedure to turn tones and alerts on or off on your radio.

- 1 Do one of the following:
 - Press the programmed **Tones/Alerts** button. Skip the following steps.
 - Press  to access the menu.

2 Press P1 or P2 to Utilities. Press to select.

3 Press P1 or P2 to Radio Settings. Press to select.

4 Press P1 or P2 to Tones/Alerts. Press to select.

5 Press P1 or P2 to All Tones. Press to select.

6 Do one of the following:

- Press P1 or P2 to On. Press to select. The display shows ✓ beside On.
 - Press P1 or P2 to Off. Press to select. The display shows ✓ beside Off.
-

Turning Power Up Tone On or Off

Follow the procedure to turn Power Up Tone on or off on your radio.

1 Press to access the menu.

2 Press P1 or P2 to Utilities. Press to select.

3 Press P1 or P2 to Radio Settings. Press to select.

4 Press P1 or P2 to Tones/Alerts. Press to select.

5 Press P1 or P2 to Power Up. Press to select.

6 Do one of the following:

- Press P1 or P2 to On. Press to select. The display shows ✓ beside On.

- Press **◀P1** or **P2▶** to Off. Press **OK** to select. The display shows ✓ beside Off.

8.8

Setting Tones/Alerts Volume Offset Levels

This feature adjusts the volume of the tones or alerts, allowing it to be higher or lower than the voice volume. Follow the procedure to set the tones and alerts volume offset levels on your radio.

- 1 Press **OK** to access the menu.
- 2 Press **◀P1** or **P2▶** to Utilities. Press **OK** to select.
- 3 Press **◀P1** or **P2▶** to Radio Settings. Press **OK** to select.
- 4 Press **◀P1** or **P2▶** to Tones/Alerts. Press **OK** to select.

- 5 Press **◀P1** or **P2▶** to Vol. Offset. Press **OK** to select.

- 6 Press **◀P1** or **P2▶** to the required volume offset level.

A feedback tone sounds with each corresponding volume offset level.

- 7 Do one of the following:



- Press **OK** to select. The required volume offset level is saved.
- Press **↶** to exit. The changes are discarded.



8.9



Turning Talk Permit Tone On or Off



Follow the procedure to turn Talk Permit Tone on or off on your radio.

- 1 Press **OK** to access the menu.







2 Press  or  to Utilities. Press  to select.

3 Press  or  to Radio Settings. Press  to select.

4 Press  or  to Tones/Alerts. Press  to select.

5 Press  or  to Talk Permit. Press  to select.

6 Do one of the following:



- Press  or  to On. Press  to select. The display shows ✓ beside On.
 - Press  or  to Off. Press  to select. The display shows ✓ beside Off.
-

8.10



Setting Languages



Follow the procedure to set the languages on your radio.

1 Press  to access the menu.

2 Press  or  to Utilities. Press  to select.

3 Press  or  to Radio Settings. Press  to select.

4 Press  or  to Languages. Press  to select.



5 Press  or  to the required language. Press  to select. The display shows ✓ beside the selected language.



8.11



Turning LED Indicators On or Off







Follow the procedure to turn the LED indicators on or off on your radio.

- 1 Press  to access the menu.

- 2 Press  or  to Utilities. Press  to select.

- 3 Press  or  to Radio Settings. Press  to select.

- 4 Press  or  to LED Indicator. Press  to select.



- 5 Do one of the following:
 - Press  or  to On. Press  to select. The display shows ✓ beside On.
 - Press  or  to Off. Press  to select. The display shows ✓ beside Off.



8.12



Turning Introduction Screen On or Off



You can enable and disable the Introduction Screen by following the procedure.



- 1 Press  to access the menu.

- 2 Press  or  to Utilities. Press  to select.

- 3 Press  or  to Radio Settings. Press  to select.

- 4 Press  or  to Intro Screen. Press  to select.

- 5 Do one of the following:
 - Press  or  to On. Press  to select. The display shows ✓ beside On.

- Press  or  to Off. Press  to select. The display shows ✓ beside Off.

8.13

Turning Voice Announcement On or Off

This feature enables the radio to audibly indicate the current zone or channel the user has just assigned, or the programmable button the user has just pressed.

This is typically useful when the user has difficulty reading the content shown on the display.

This audio indicator can be customized according to customer requirements. Follow the procedure to turn Voice Announcement on or off on your radio.







NOTICE:



The Voice Announcement feature can only be enabled through CPS. If enabled, the Text-to-Speech feature is automatically disabled.

- 1 Do one of the following:
 - Press the programmed **Voice Announcement** button. Skip the following steps.







- Press  to access the menu.

- 2 Press  or  to Utilities. Press  to select.

- 3 Press  or  to Radio Settings. Press  to select.

- 4 Press  or  to Voice Announcement. Press  to select.

- 5 Do one of the following:



- Press  or  to On. Press  to select. The display shows ✓ beside On.
- Press  or  to Off. Press  to select. The display shows ✓ beside Off.



8.14



Turning Automatic Call Forwarding On or Off



You can enable your radio to automatically forward voice calls to another radio.



- 1 Press  to access the menu.

- 2 Press  or  to Utilities. Press  to select.

- 3 Press  or  to Radio Settings. Press  to select.

- 4 Press  or  to Call Forward. Press  to select.

- 5 Do one of the following:
 - Press  or  to On. Press  to select. The display shows ✓ beside On.



- Press  or  to Off. Press  to select. The display shows ✓ beside Off.
-



8.15



Setting Menu Timer



You can set the time your radio stays in the menu before it automatically switches to the Home screen. Follow the procedure to set the menu timer.

- 1 Press  to access the menu.

 - 2 Press  or  to Utilities. Press  to select.

 - 3 Press  or  to Radio Settings. Press  to select.

 - 4 Press  or  to Menu Timer. Press  to select.
-

- 5 Press  or  to the required setting. Press  to select.
-



8.16



Turning Analog Microphone AGC On or Off



The Analog Microphone Automatic Gain Control (AGC) controls the microphone gain of the radio automatically while transmitting on an analog system.

This feature suppresses loud audio or boosts soft audio to a preset value in order to provide a consistent level of audio. Follow the procedure to turn Analog Microphone AGC on or off on your radio.







- 1 Press  to access the menu.

 - 2 Press  or  to Utilities. Press  to select.

 - 3 Press  or  to Radio Settings. Press  to select.
-

- 4 Press  or  to Mic AGC-A. Press  to select.
-

- 5 Do one of the following:

- Press  or  to On. Press  to select. The display shows ✓ beside On.
 - Press  or  to Off. Press  to select. The display shows ✓ beside Off.
-



8.17



Turning Digital Microphone AGC On or Off



The Digital Microphone Automatic Gain Control (AGC) controls the microphone gain of the radio automatically while transmitting on a digital system.

This feature suppresses loud audio or boosts soft audio to a preset value in order to provide a consistent level of audio. Follow the procedure to turn Digital Microphone AGC on or off on your radio.







- 1 Press  to access the menu.
-

2 Press  or  to Utilities. Press  to select.

3 Press  or  to Radio Settings. Press  to select.

4 Press  or  to Mic AGC-D. Press  to select.

5 Do one of the following:

- Press  or  to On. Press  to select. The display shows ✓ beside On.
 - Press  or  to Off. Press  to select. The display shows ✓ beside Off.
-

8.18



Turning Intelligent Audio On or Off

Your radio automatically adjusts the audio volume to overcome current background noise in the environment, inclusive of both stationary and non-stationary noise sources. This is a receive-only feature and does not affect



transmission audio. Follow the procedure to turn Intelligent Audio on or off on your radio.

1 Do one of the following:



- Press the programmed **Intelligent Audio** button. Skip the steps below.
 - Press  to access the menu.
-

2 Press  or  to Utilities. Press  to select.

3 Press  or  to Radio Settings. Press  to select.

4 Press  or  to Intelligent Audio. Press  to select.

5 Do one of the following:

- Press  or  to On. Press  to select. The display shows ✓ beside On.

- Press **◀P1** or **P2▶** to Off. Press **OK** to select. The display shows ✓ beside Off.
-

8.19

Turning Trill Enhancement On or Off

You can enable this feature when you are speaking in a language that contains many words with alveolar trill (rolling "R") pronunciations. Follow the procedure to turn Trill Enhancement on or off on your radio.

- 1 Do one of the following:
 - Press the programmed **Trill Enhancement** button. Skip the steps below.
 - Press **OK** to access the menu.
 - 2 Press **◀P1** or **P2▶** to Utilities. Press **OK** to select.
 - 3 Press **◀P1** or **P2▶** to Radio Settings. Press **OK** to select.
-

- 4 Press **◀P1** or **P2▶** to Trill Enhance. Press **OK** to select.
-

- 5 Do one of the following:



- Press **◀P1** or **P2▶** to On. Press **OK** to select. The display shows ✓ beside On.
 - Press **◀P1** or **P2▶** to Off. Press **OK** to select. The display shows ✓ beside Off.
-



8.20



Turning Acoustic Feedback Suppressor On or Off

The feature allows you to minimize acoustic feedback in received calls. Follow the procedure to turn Acoustic Feedback Suppressor on or off on your radio.







- 1 Do one of the following:
 - Press the programmed **AF Suppressor** button. Skip the following steps.
 - Press **OK** to access the menu.
-

2 Press  or  to Utilities. Press  to select.

3 Press  or  to Radio Settings. Press  to select.

4 Press  or  to AF Suppressor. Press  to select.

5 Do one of the following:

- Press  or  to On. Press  to select. The display shows ✓ beside On.
 - Press  or  to Off. Press  to select. The display shows ✓ beside Off.
-

8.21

General Radio Information



Your radio contains information on various general parameters.

The general information of your radio is as follows:

- Battery information.
- Radio alias and ID.
- Firmware and Codeplug versions.
- Software update.
- GNSS information.



NOTICE:



Press  to return to the previous screen. Long press  to return to the Home screen. The radio exits the current screen once the inactivity timer expires.



8.21.1

Accessing Battery Information

Displays information of your radio battery.

- 1 Press  to access the menu.

- 2 Press  or  to Utilities. Press  to select.

3 Press  or  to Radio Info. Press  to select.

4 Press  or  to Battery Info. Press  to select.



The display shows the battery information.



8.21.2

Checking Radio Alias and ID

1 Do one of the following:

- Press the programmed **Radio Alias and ID** button. Skip the following steps. A positive indicator tone sounds.
 - Press  to access the menu.
-

2 Press  or  to Utilities. Press  to select.

3 Press  or  to Radio Info. Press  to select.



4 Press  or  to My ID. Press  to select.



The first text line shows the radio alias. The second text line shows the radio ID.



8.21.3

Checking Firmware and Codeplug Versions

1 Press  to access the menu.

2 Press  or  to Utilities. Press  to select.

3 Press  or  to Radio Info. Press  to select.

4 Press  or  to Versions. Press  to select.



The display shows the current firmware and codeplug versions.



8.21.4



Checking Software Update Information

This feature shows the date and time of the latest software update carried out through OTAP or Wi-Fi. Follow the procedure to check the software update information on your radio.

- 1 Press  to access the menu.

- 2 Press  or  to Utilities. Press  to select.

- 3 Press  or  to Radio Info. Press  to select.

- 4 Press  or  to SW Update. Press  to select.

The display shows the date and time of the latest software update.

Software Update menu is only available after at least one successful OTAP or Wi-Fi session. See [Over-the-Air Programming on page 124](#) for more information.

8.22

Received Signal Strength Indicator

This feature allows you to view the Received Signal Strength Indicator (RSSI) values.

The display shows the **RSSI** icon at the top right corner. See [Display Icons](#) for more information on the **RSSI** icon.

8.22.1

Viewing RSSI Values

At the home screen, press **Volume Down** button five times (- - - - -), then immediately press **Volume Up** button five times (+ + + + +) all within five seconds.

The display shows the current RSSI values.



To return to the home screen, press and hold .



8.23



Viewing Enterprise Wi-Fi Certificate Details

You can view the details of the selected Enterprise Wi-Fi Certificate.

- 1 Press  to access the menu.

- 2 Press  or  to Utilities. Press  to select.

- 3 Press  or  to Certificate Menu. Press  to select.
✓ appears beside ready certificates.

- 4 Press  or  to the required certificate.
Press  to select.

Your radio displays the full details of the certificate.



NOTICE:

For unready certificates, the display shows only Status.

Authorized Accessories List

Motorola Solutions provides a list of accessories to improve the productivity of your radio.

Antenna

- VHF, 136–144 MHz, 5.0 cm, Stubby Antenna (PMAD4144_)
- VHF, 144–156 MHz, 5.0 cm, Stubby Antenna (PMAD4145_)
- VHF, 156–174 MHz, 5.0 cm, Stubby Antenna (PMAD4146_)
- VHF, 136–144 MHz, 9.0 cm, Whip Antenna (PMAD4154_)
- VHF, 144–156 MHz, 9.0 cm, Whip Antenna (PMAD4155_)
- VHF, 156–174 MHz, 9.0 cm, Whip Antenna (PMAD4156_)
- UHF, 403–425 MHz, 4.5 cm, Stubby Antenna (PMAE4093_)
- UHF, 420–445 MHz, 4.5 cm, Stubby Antenna (PMAE4094_)

- UHF, 435–470 MHz, 4.5 cm, Stubby Antenna (PMAE4095_)
- UHF, 445–480 MHz, 4.5 cm, Stubby Antenna (PMAE4099_)

Batteries

- BT100x Lithium-Ion 2300 mAh Battery Pack (PMNN4468_)

Carry Devices

- Nylon Wrist Strap (PMLN6074_)
- Flexible Quick Release Hand Strap (PMLN7076_)
- Heavy-Duty Swivel Belt Clip (PMLN7128_)
- Swivel Carry Holster (PMLN7190_)

Chargers

- Standard Multi-Unit Charger (PMLN7093_)
- Standard Single Unit Charger (PMLN7094_)
- Standard Multi-Unit Charger, AUS/NZ Plug (PMLN7103_)
- Standard Single Unit Charger, AUS/NZ Plug (PMLN7111_)

- Power Supply Adaptor 100 V–240 V, Micro USB (PS000227A01)
- Micro USB Power Supply Adaptor, AC/DC Switch Mode, Wall Cube, 5 W, 100 V–240 V, AUS/NZ Plug (PS000042A14)

Earbuds and Earpieces

- Earbud with In-line Mic/PTT, MagOne (PMLN7156_)
- 2-Wire with Transparent Tube, Black (PMLN7157_)
- 1-Wire Surveillance Earpiece, In-Line Mic and PTT (PMLN7158_)
- Adjustable D-Style with In-Line Mic and PTT (PMLN7159_)
- Swivel Earpiece, In-line Mic and PTT (PMLN7189_)
- Transparent Acoustic Tube (RLN6242_)
- High Noise Yellow Foam Earpieces (5080384F72)

Miscellaneous

- Battery Door (PMLN7074_)

Wireless

- Push-to-Talk Module, without Charger (NNTN8191_)
- 1-Wire Earbud, 29 cm Cord, Black (NNTN8294_)
- 1-Wire Earbud, 116 cm Cord, Black (NNTN8295_)
- Eartips for Operations Critical Wireless Earbuds (Replacement for NNTN8294_ and NNTN8295_) (NNTN8299_)
- Wireless Neckloop Y-adapter and retention hook for Completely Discreet Kit (NNTN8385_)
- Discreet Surveillance Kit (NNTN8433_)
- Business Wireless Accessory Kit (PMLN6463_)
- Operations Critical Wireless 1-Wire Surveillance Kit with Translucent Tube (PMLN7052_)
- Completely Discreet Earpiece Kit (RLN4922_)⁵
- XBT Behind-the-Neck, Non-secure Wireless Heavy Duty Headset (RLN6490_)
- XBT Overhead, Non-secure Wireless Heavy Duty Headset (RLN6491_)
- Swivel Earpiece with In-Line Microphone (RLN6550_)⁵

⁵ Contact your dealer on the availability of these accessories.

- Non-Secure HK200 Mobile Bluetooth Headset (89409N)

Limited Warranty

MOTOROLA SOLUTIONS COMMUNICATION PRODUCTS

I. WHAT THIS WARRANTY COVERS AND FOR HOW LONG:

Motorola Solutions, Inc. ("Motorola Solutions") warrants the Motorola Solutions manufactured Communication Products listed below ("Product") against defects in material and workmanship under normal use and service for a period of time from the date of purchase as scheduled below:

Portable Radios	Two (2) Years
Product Accessories	One (1) Year

Motorola Solutions, at its option, will at no charge either repair the Product (with new or reconditioned parts), replace it (with a new or reconditioned Product), or refund the purchase price of the Product during the warranty period provided it is returned in accordance with the terms of this warranty. Replaced parts or boards are warranted

for the balance of the original applicable warranty period. All replaced parts of Product shall become the property of Motorola Solutions.

This express limited warranty is extended by Motorola Solutions to the original end user purchaser only and is not assignable or transferable to any other party. This is the complete warranty for the Product manufactured by Motorola Solutions. Motorola Solutions assumes no obligations or liability for additions or modifications to this warranty unless made in writing and signed by an officer of Motorola Solutions.

Unless made in a separate agreement between Motorola Solutions and the original end user purchaser, Motorola Solutions does not warrant the installation, maintenance or service of the Product.

Motorola Solutions cannot be responsible in any way for any ancillary equipment not furnished by Motorola Solutions which is attached to or used in connection with the Product, or for operation of the Product with any ancillary equipment, and all such equipment is expressly excluded from this warranty. Because each system which may use the Product is unique, Motorola Solutions disclaims liability for range, coverage, or operation of the system as a whole under this warranty.

II. GENERAL PROVISIONS

This warranty sets forth the full extent of Motorola Solutions responsibilities regarding the Product. Repair, replacement or refund of the purchase price, at Motorola Solutions option, is the exclusive remedy. THIS WARRANTY IS GIVEN IN LIEU OF ALL OTHER EXPRESS WARRANTIES. IMPLIED WARRANTIES, INCLUDING WITHOUT LIMITATION, IMPLIED WARRANTIES OF MERCHANTABILITY AND FITNESS FOR A PARTICULAR PURPOSE, ARE LIMITED TO THE DURATION OF THIS LIMITED WARRANTY. IN NO EVENT SHALL MOTOROLA SOLUTIONS BE LIABLE FOR DAMAGES IN EXCESS OF THE PURCHASE PRICE OF THE PRODUCT, FOR ANY LOSS OF USE, LOSS OF TIME, INCONVENIENCE, COMMERCIAL LOSS, LOST PROFITS OR SAVINGS OR OTHER INCIDENTAL, SPECIAL OR CONSEQUENTIAL DAMAGES ARISING OUT OF THE USE OR INABILITY TO USE SUCH PRODUCT, TO THE FULL EXTENT SUCH MAY BE DISCLAIMED BY LAW.

III. STATE LAW RIGHTS:

SOME STATES DO NOT ALLOW THE EXCLUSION OR LIMITATION OF INCIDENTAL OR CONSEQUENTIAL DAMAGES OR LIMITATION ON HOW LONG AN IMPLIED

WARRANTY LASTS, SO THE ABOVE LIMITATION OR EXCLUSIONS MAY NOT APPLY.

This warranty gives specific legal rights, and there may be other rights which may vary from state to state.

IV. HOW TO GET WARRANTY SERVICE

You must provide proof of purchase (bearing the date of purchase and Product item serial number) in order to receive warranty service and, also, deliver or send the Product item, transportation and insurance prepaid, to an authorized warranty service location. Warranty service will be provided by Motorola Solutions through one of its authorized warranty service locations. If you first contact the company which sold you the Product (for example, dealer or communication service provider), it can facilitate your obtaining warranty service. You can also call Motorola Solutions at 1-800-927-2744.

V. WHAT THIS WARRANTY DOES NOT COVER

- 1 Defects or damage resulting from use of the Product in other than its normal and customary manner.

- 2 Defects or damage from misuse, accident, water, or neglect.
- 3 Defects or damage from improper testing, operation, maintenance, installation, alteration, modification, or adjustment.
- 4 Breakage or damage to antennas unless caused directly by defects in material workmanship.
- 5 A Product subjected to unauthorized Product modifications, disassembles or repairs (including, without limitation, the addition to the Product of non-Motorola Solutions supplied equipment) which adversely affect performance of the Product or interfere with Motorola Solutions normal warranty inspection and testing of the Product to verify any warranty claim.
- 6 Product which has had the serial number removed or made illegible.
- 7 Rechargeable batteries if:
 - any of the seals on the battery enclosure of cells are broken or show evidence of tampering.
 - the damage or defect is caused by charging or using the battery in equipment or service other than the Product for which it is specified.
- 8 Freight costs to the repair depot.
- 9 A Product which, due to illegal or unauthorized alteration of the software/firmware in the Product, does not function in accordance with Motorola Solutions published specifications or the FCC certification labeling in effect for the Product at the time the Product was initially distributed from Motorola Solutions.
- 10 Scratches or other cosmetic damage to Product surfaces that does not affect the operation of the Product.
- 11 Normal and customary wear and tear.

VI. PATENT AND SOFTWARE PROVISIONS

Motorola Solutions will defend, at its own expense, any suit brought against the end user purchaser to the extent that it is based on a claim that the Product or parts infringe a United States patent, and Motorola Solutions will pay those costs and damages finally awarded against the end user purchaser in any such suit which are attributable to any such claim, but such defense and payments are conditioned on the following:

- 1 Motorola Solutions will be notified promptly in writing by such purchaser of any notice of such claim,

- 2 Motorola Solutions will have sole control of the defense of such suit and all negotiations for its settlement or compromise, and
- 3 Should the Product or parts become, or in Motorola Solutions opinion be likely to become, the subject of a claim of infringement of a United States patent, that such purchaser will permit Motorola Solutions, at its option and expense, either to procure for such purchaser the right to continue using the Product or parts or to replace or modify the same so that it becomes non-infringing or to grant such purchaser a credit for the Product or parts as depreciated and accept its return. The depreciation will be an equal amount per year over the lifetime of the Product or parts as established by Motorola Solutions.

Motorola Solutions will have no liability with respect to any claim of patent infringement which is based upon the combination of the Product or parts furnished hereunder with software, apparatus or devices not furnished by Motorola Solutions, nor will Motorola Solutions have any liability for the use of ancillary equipment or software not furnished by Motorola Solutions which is attached to or used in connection with the Product. The foregoing states the entire liability of Motorola Solutions with respect to infringement of patents by the Product or any parts thereof.

Laws in the United States and other countries preserve for Motorola Solutions certain exclusive rights for copyrighted Motorola Solutions software such as the exclusive rights to reproduce in copies and distribute copies of such Motorola Solutions software. Motorola Solutions software may be used in only the Product in which the software was originally embodied and such software in such Product may not be replaced, copied, distributed, modified in any way, or used to produce any derivative thereof. No other use including, without limitation, alteration, modification, reproduction, distribution, or reverse engineering of such Motorola Solutions software or exercise of rights in such Motorola Solutions software is permitted. No license is granted by implication, estoppel or otherwise under Motorola Solutions patent rights or copyrights.

VII. GOVERNING LAW

This Warranty is governed by the laws of the State of Illinois, U.S.A.

VIII. For Australia Only

This warranty is given by Motorola Solutions Australia Pty Limited (ABN 16 004 742 312) of Tally Ho Business Park, 10 Wesley Court. Burwood East, Victoria.

Our goods come with guarantees that cannot be excluded under the Australia Consumer Law. You are entitled to a replacement or refund for a major failure and compensation for any other reasonably foreseeable loss or damage. You are also entitled to have the goods repaired or replaced if the goods fail to be of acceptable quality and the failure does not amount to a major failure.

Motorola Solutions Australia's limited warranty above is in addition to any rights and remedies you may have under the Australian Consumer Law. If you have any queries, please call Motorola Solutions Australia at 1800 457 439. You may also visit our website: http://www.motorolasolutions.com/XA-EN/Pages/Contact_Us for the most updated warranty terms.

www.motorolasolutions.com/mototrbo

MOTOROLA, MOTO, MOTOROLA SOLUTIONS and the Stylized M Logo are trademarks or registered trademarks of Motorola Trademark Holdings, LLC and are used under license. All other trademarks are the property of their respective owners. © 2017 and 2021 Motorola Solutions, Inc. All rights reserved.

